



Planning Commission Staff Report

Meeting Date: November 13, 2014 Agenda Item Number: 9C

Subject: Tentative Subdivision Map Case Number TM14-002
Applicant: Pinnacle Land Holdings, LLC
Project Summary: To develop a 43 lot, single-family residential, common open space subdivision
Recommendation: Approval with Conditions
Prepared by: Trevor Lloyd - AICP, Senior Planner
Planning and Development Division
Washoe County Community Services Department
Phone: 775.328.3620
Email: tlloyd@washoecounty.us

Description

Tentative Subdivision Map Case Number TM14-002 (Autumn Trails) – Possible approval of a Tentative Subdivision Map to develop a 43 lot, single-family residential, common open space subdivision. Lots will range in size from 21,451 to 58,393 square feet, and the common open space area will be approximately 12.3 acres.

- Applicant/Property Owner: Pinnacle Land Holdings, LLC
- Address/Location: 0 Hayfield Drive
- Assessor's Parcel Number: 534-420-08
- Parcel Size: ±47.608 acres
- Master Plan Category: Suburban Residential (SR)
- Regulatory Zone: Low Density Suburban (LDS)
- Area Plan: Spanish Springs
- Citizen Advisory Board: Spanish Springs
- Development Code: Authorized in Article 608, Tentative Subdivision Maps and Article 408, Common Open Space Development

- Commission District: 4 – Commissioner Hartung
- Section/Township/Range: Within Section 25, T21N, R20E, MDM
Washoe County, NV

Staff Report Contents

Project Description..... 1
Tentative Subdivision Map 3
Vicinity Map 4
Site Plan 5
Project Evaluation..... 5
Spanish Springs Citizen Advisory Board (SSCAB)..... 7
Reviewing Agencies..... 7
Recommendation..... 9
Motion..... 9
Appeal Process.....10

Exhibits Contents

Conditions of Approval.....Exhibit A
Subdivision Grading PlansExhibit B
Citizen Advisory Board Minutes Exhibit C
Health District Letter Email..... Exhibit D
Health District Vector Borne LetterExhibit E
Engineering and Capital Projects MemorandumExhibit F
Truckee Meadows Fire Protection District Letter Exhibit G
Washoe County School District Comments..... Exhibit H
Public Notice..... Exhibit I

Tentative Subdivision Map

The purpose of a Tentative Subdivision Map is to:

- Allow the creation of saleable lots;
- Implement the Washoe County Master Plan, including the Area Plans, and any specific plans adopted by the County;
- Establish reasonable standards of design and reasonable procedures for subdivision and re-subdivision in order to further the orderly layout and use of land and insure proper legal descriptions and monumenting of subdivided land; and,
- Safeguard the public health, safety and general welfare by establishing minimum standards of design and development for any subdivision platted in the unincorporated area of Washoe County.

If the Planning Commission grants an approval of the Tentative Subdivision Map, that approval is subject to Conditions of Approval. Conditions of Approval are requirements that need to be completed during different stages of the proposed project. Those stages are typically:

- Prior to recordation of a final map.
- Prior to obtaining a final inspection and/or a certificate of occupancy on a structure.
- Prior to the issuance of a business license or other permits/licenses.
- Some Conditions of Approval are referred to as "Operational Conditions". These conditions must be continually complied with for the life of the project.

The Conditions of Approval for Tentative Subdivision Map Case Number TM14-002 are attached to this staff report and will be included with the Action Order.

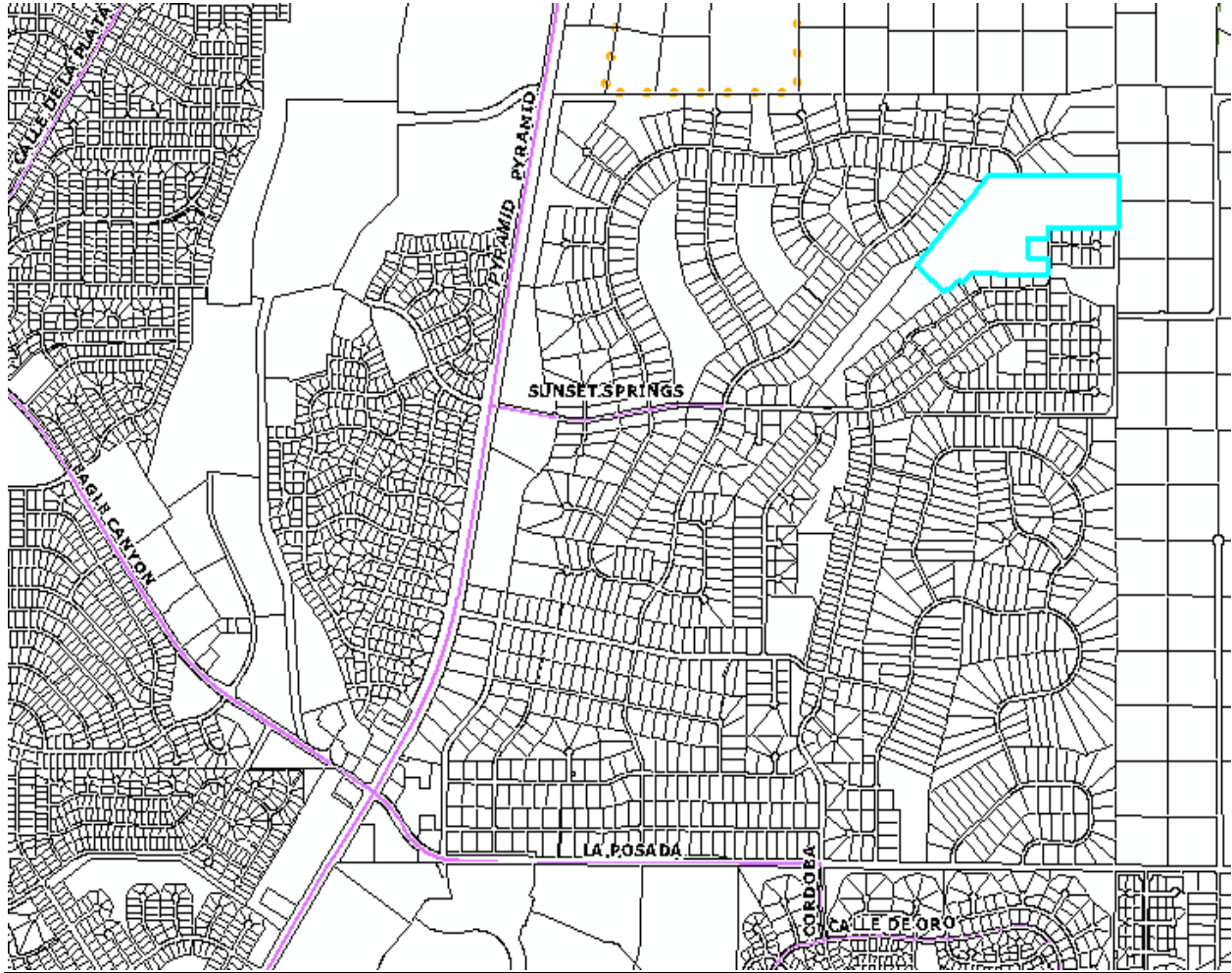

Vicinity Map

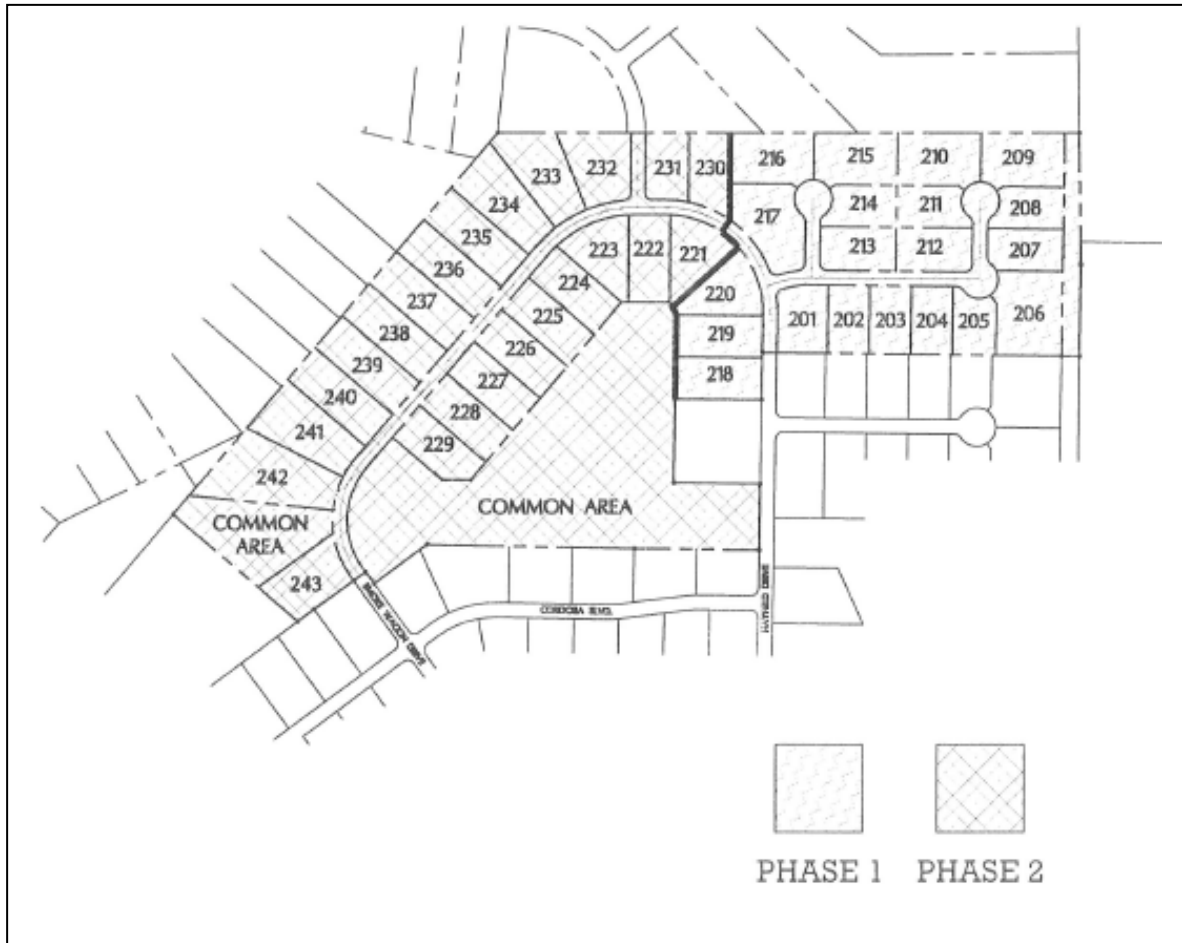

Site Plan

Project Evaluation

The applicant is proposing to develop a 43 lot subdivision on a ±47.6 acre property. The property is the site of a formerly active Tentative Map known as Sky Ranch North that was approved for 185 lots in which 154 have been recorded. The Sky Ranch North subdivision has since expired and the remaining allowable density is 31 dwelling units. The applicants have filed a Regulatory Zone Amendment application, case number RZA14-004, on six acres of the property to increase the overall density by twelve additional dwelling units. The Regulatory Zone Amendment must be approved by the Planning Commission and adopted by the Board of County Commissioners before the subject Tentative Map becomes effective.

The proposed project will maintain a similar pattern of development, with lot sizes consistent with the adjoining Sky Ranch North subdivision. The design of the subdivision will provide large parcels along the perimeter of the subdivision to create a transition from the smaller properties within the interior.

Staff has reviewed the Tentative Map and has found the proposed subdivision to be in conformance with the Spanish Springs Area Plan, the Washoe County Master Plan and the

Washoe County Development Code. The subdivision meets the density requirements, lot sizes and width requirements and all landscaping and buffering requirements.

All properties to the north, west and south are zoned low density suburban (LDS) and the properties to the east are zoned general rural (GR). All lot sizes and widths within the proposed subdivision will comply with the minimum standards for LDS zoned lots. Also, finished grades should not exceed a maximum slope of 3 horizontal to 1 vertical.

Subdivision Design

The applicants are asking to develop 43 lots on ±47.6 acres; however, the property will be developed as a Common Open Space Subdivision. Article 408, Common Open Space Development, of the Washoe County Development Code allows flexibility of design for subdivisions and therefore modification of lot standard designs; however, the overall density of the site will not allow more than 43 lots throughout the property. The lots will range in size from 21,451 square feet to 58,393 square feet. Approximately 12.3 acres shall be preserved as common area and maintained as open space for the benefit of the residents of Autumn Trails. Most of the common area will remain undisturbed with the exception of those areas identified as a detention facility. The Homeowners Association shall assume the responsibility for maintenance of all common areas. Sidewalks are proposed to be located along one side of the street throughout the subdivision. Additionally, there is an access road/trail along the eastern boundary that provides pedestrian access to neighboring developments.

Water and Sewer

The Truckee Meadows Water Authority (TMWA) will provide the water service for the development utilizing imported water primarily from the Truckee River. Sanitary sewer service is currently provided by Washoe County utilizing a force main located in La Posada Drive which connects to the Northeast Interceptor located in Sparks. Sewer/wastewater will be delivered to the Truckee Meadows Water Reclamation Facility in Sparks.

Grading

It is anticipated that grading will be balanced throughout the site; however, imported material may be needed for structural fill. The projected amount of excavation is expected to be roughly 108,000 cubic yards of earthen material. There is a very large stockpile of dirt material located at the northern terminus of Hayfield Drive. This material was placed at this location during the construction of the previous subdivision and will be removed with the first phase of construction for this subdivision.

Traffic

It is anticipated that with the additional density, the buildout of the tentative map will likely cause the 10 year design Average Daily Traffic (ADT) to exceed 2,000 on Sunset Springs Lane. This forecast is based on International Transportation Engineers (ITE) trip rate of 9.57 trips/dwelling unit. As there are homes between Omni Drive and Cordoba Blvd. that have direct access to Sunset Springs Lane, staff is recommending a condition to slow traffic along certain sections of Sunset Springs Lane with the use of traffic calming mitigation techniques. The applicant will work with staff to determine the most appropriate traffic calming mitigation techniques to utilize. Such mitigation will be required along Sunset Springs Lane between Bridle Path Terrace and Hay Bale Drive.

Spanish Springs Citizen Advisory Board (SSCAB)

The proposed project was presented by the applicant's representative at the regularly scheduled Citizen Advisory Board meeting on September 10, 2014. The attached CAB minutes reflect discussion on the following items:

- A concern was raised regarding the rezoning of the property leading to more rezoning of other properties.
- A question was asked about tying into Bridal Path Terrace, with traffic connections.
- A question was asked about the drainage to and from the site and which direction the water will flow. The applicant assured the crowd that water will not flow north toward Bridal Path Terrace and there are detention ponds where the water flows.
- A question was asked about who will provide water service. A "will serve" letter from Washoe County Water Resources has been received. (Truckee Meadows Water Authority will be the service provider after the merger with the Washoe County Water Resources becomes effective).

Reviewing Agencies

- Washoe County Planning and Development Division addressed lot design, common open space criteria, and compliance with the Washoe County Master Plan and the removal of the existing stockpiled material.
Contact: Trevor Lloyd, 328-3620 tlloyd@washoecounty.us
- Washoe County Engineering and Capital Projects Division addressed the adequacy of easements, drainage, grading, storm-water, etc.
Contact: Leo Vesely, 328-2040 lvesely@washoecounty.us
- Washoe County Engineering and Capital Projects Division – Water Services required compliance with TMWA infrastructure and connection fee requirements.
Contact: Pam Parenti, 834-8037 pparenti@tmwa.com
- Washoe County Environmental Health District addressed sewage disposal, public water supply systems, water pollution, timing of construction activity, etc.
Contact: Chris Anderson, 328-2632 canderson@washoecounty.us
- Washoe County Health District – Vector Borne Diseases addressed low flow channel and storm water detention requirements, and xeriscape catchment areas adjoining turf areas.
Contact: Jeff Jeppson, 328-2632 jjeppson@washoecounty.us
- Truckee Meadows Fire Protection District addressed a maintenance plan for the common open space areas, defensible space, landscaping plan for compliance with the International Wildland Urban Interface Code and compliance with WCC 60.
Contact: Amy Ray, 326-6000 aray@washoecounty.us
- Washoe County School District required a disclosure to each homebuyer that students in this subdivision may be assigned to the nearest schools with available capacity.

Contact: Mike Boster, 789-3810 mboster@washoeschools.net

Staff Comment on Required Findings

Section 110.608.25 of Article 608, Tentative Subdivision Maps, within the Washoe County Development Code, requires that all of the following findings be made to the satisfaction of the Washoe County Planning Commission before granting approval of the subdivision request. Staff has completed an analysis of the application and has determined that the proposal is in compliance with the required findings as follows.

- 1) **Plan Consistency.** That the proposed map is consistent with the Master Plan and any specific plan.

Staff Comment: The proposed map complies with all goals and policies of the Spanish Springs Area Plan. There are no Specific Plans associated with this request.

- 2) **Design or Improvement.** That the design or improvement of the proposed subdivision is consistent with the Master Plan and any specific plan.

Staff Comment: The subdivision design complies with policies of the Spanish Springs Area Plan and all elements of the Washoe County Master Plan.

- 3) **Type of Development.** That the site is physically suited for the type of development proposed.

Staff Comment: The subdivision is an infill development that is surrounded by similar residential developments.

- 4) **Availability of Services.** That the subdivision will meet the requirements of Article 702, Adequate Public Facilities Management System.

Staff Comment: There are adequate services and infrastructure to support the development of this property. The proposed subdivision complies with all provisions of Article 702, Adequate Public Facilities Management System.

- 5) **Fish or Wildlife.** That neither the design of the subdivision nor any proposed improvements is likely to cause substantial environmental damage, or substantial and avoidable injury to any endangered plant, wildlife or their habitat.

Staff Comment: There are no identified endangered plants or wildlife on the subject property or within close proximity to the subject property.

- 6) **Public Health.** That the design of the subdivision or type of improvement is not likely to cause significant public health problems.

Staff Comment: The proposed subdivision is a similar residential development with the surrounding subdivisions and the design of the subdivision is not likely to cause significant public health problems.

- 7) Easements. That the design of the subdivision or the type of improvements will not conflict with easements acquired by the public at large for access through, or use of property within, the proposed subdivision.

Staff Comment: The design of the subdivision does not conflict with existing easements and provides adequate access for the public to surrounding properties.

- 8) Access. That the design of the subdivision provides any necessary access to surrounding, adjacent lands and provides appropriate secondary access for emergency vehicles.

Staff Comment: The design of the subdivision provides necessary access to surrounding, adjacent lands. Multiple access points have been provided within this subdivision.

- 9) Dedications. That any land or improvements to be dedicated to the County is consistent with the Master Plan.

Staff Comment: All lands and improvements to be dedicated to Washoe County are consistent with the Master Plan.

- 10) Energy. That the design of the subdivision provides, to the extent feasible, for future passive or natural heating or cooling opportunities in the subdivision.

Staff Comment: Adequate opportunities shall be provided for future passive or natural heating or cooling opportunities.

Recommendation

Those agencies which reviewed the application recommended conditions in support of approval of the project. Therefore, after a thorough analysis and review, Tentative Subdivision Map Case Number TM14-002 is being recommended for Approval with Conditions. Staff offers the following motion for the Board's consideration.

Motion

"I move that after giving reasoned consideration to the information contained in the staff report and information received during the public hearing, the Washoe County Planning Commission approve Tentative Subdivision Map Case Number TM14-002 for Pinnacle Land Holdings, LLC, with the Conditions attached as Exhibit A of the staff report, having made all ten findings in accordance with Washoe County Development Code Section 110.608.25.

- 1) Plan Consistency. That the proposed map is consistent with the Master Plan and the Spanish Springs Area Plan;
- 2) Design or Improvement. That the design or improvement of the proposed subdivision is consistent with the Master Plan and any specific plan;
- 3) Type of Development. That the site is physically suited for the type of development proposed;

- 4) Availability of Services. That the subdivision will meet the requirements of Article 702, Adequate Public Facilities Management System;
- 5) Fish or Wildlife. That neither the design of the subdivision nor any proposed improvements is likely to cause substantial environmental damage, or substantial and avoidable injury to any endangered plant, wildlife or their habitat;
- 6) Public Health. That the design of the subdivision or type of improvement is not likely to cause significant public health problems;
- 7) Easements. That the design of the subdivision or the type of improvements will not conflict with easements acquired by the public at large for access through, or use of property within, the proposed subdivision;
- 8) Access. That the design of the subdivision provides any necessary access to surrounding, adjacent lands and provides appropriate secondary access for emergency vehicles;
- 9) Dedications. That any land or improvements to be dedicated to the County is consistent with the Master Plan; and
- 10) Energy. That the design of the subdivision provides, to the extent feasible, for future passive or natural heating or cooling opportunities in the subdivision."

Appeal Process

Washoe County Planning Commission action will be effective 10 days after the public hearing date, unless the action is appealed to the Washoe County Board of County Commissioners, in which case the outcome of the appeal shall be determined by the Washoe County Board of County Commissioners.

Owner/Applicant: Pinnacle Land Holdings, LLC
Attn: Michael Fiore
477 E. 9th St.
Reno, NV 89512

Representatives: K2 Engineering and Structural Design
Attn: Michael Vicks
3100 Mill Street #107
Reno, NV 89502



Conditions of Approval

Tentative Subdivision Map Case Number TM14-002

The project approved under Tentative Subdivision Map Case Number TM14-002 shall be carried out in accordance with the Conditions of Approval granted by the Washoe County Planning Commission on November 13, 2014. Conditions of Approval are requirements placed on a permit or development by each reviewing agency. These Conditions of Approval may require submittal of documents, applications, fees, inspections, amendments to plans, and more. These conditions do not relieve the applicant of the obligation to obtain any other approvals and licenses from relevant authorities required under any other act.

Unless otherwise specified, all conditions related to the approval of this Tentative Subdivision Map shall be met or financial assurance must be provided to satisfy the Conditions of Approval prior to issuance of a grading or building permit. The agency responsible for determining compliance with a specific condition shall determine whether the condition must be fully completed or whether the applicant shall be offered the option of providing financial assurance. All agreements, easements, or other documentation required by these conditions shall have a copy filed with the County Engineer and the Planning and Development Division.

Compliance with the Conditions of Approval related to this Tentative Subdivision Map is the responsibility of the applicant, his/her successor in interest, and all owners, assignees, and occupants of the property and their successors in interest. Failure to comply with any of the conditions imposed in the approval of the Tentative Subdivision Map may result in the initiation of revocation procedures.

Washoe County reserves the right to review and revise the Conditions of Approval related to this Tentative Subdivision Map should it be determined that a subsequent license or permit issued by Washoe County violates the intent of this approval.

For the purpose of conditions imposed by Washoe County, “may” is permissive and “shall” or “must” is mandatory.

Conditions of Approval are usually complied with at different stages of the proposed project. Those stages are typically:

- Prior to recordation of a final map.
- Prior to obtaining a final inspection and/or a certificate of occupancy.
- Prior to the issuance of a business license or other permits/licenses.
- Some “Conditions of Approval” are referred to as “Operational Conditions”. These conditions must be continually complied with for the life of the project.

The Washoe County Commission oversees many of the reviewing agencies/departments with the exception of the following agencies.

- **The DISTRICT BOARD OF HEALTH, through the Washoe County Health District, has jurisdiction over all public health matters in the Health District. Any conditions set by the District Health Department must be appealed to the District Board of Health.**

FOLLOWING ARE CONDITIONS OF APPROVAL REQUIRED BY THE REVIEWING AGENCIES. EACH CONDITION MUST BE MET TO THE SATISFACTION OF THE ISSUING AGENCY.

Washoe County Planning and Development Division

1. The following conditions are requirements of the Planning and Development Division, which shall be responsible for determining compliance with these conditions.

Contact Name – Trevor Lloyd, 775.328.3620, tlloyd@washoecounty.us

- a. The applicant shall demonstrate substantial conformance to the plans approved as part of this special use permit.
- b. The subdivision shall be in substantial conformance with the provisions of Washoe County Development Code Article 604, Design Requirements, and Article 608, Tentative Subdivision Maps.
- c. Final maps and final construction drawings shall comply with all applicable statutes, ordinances, rules, regulations and policies in effect at the time of submittal of the tentative map or, if requested by the developer and approved by the applicable agency, those in effect at the time of approval of the final map.
- d. The subdivider shall present to Washoe County a final map, prepared in accordance with the tentative map, for the entire area for which a tentative map has been approved, or one of a series of final maps, each covering a portion of the approved tentative map, within four years after the date of approval of the tentative map or within two years of the date of approval for subsequent final maps. On subsequent final maps, that date may be extended by two years if the extension request is received prior to the expiration date.
- e. Final maps shall be in substantial compliance with all plans and documents submitted with and made part of this tentative map request, as may be amended by action of the final approving authority.
- f. All final maps shall contain the applicable portions of the following statement:

The Tentative Map for TM14-002 (Autumn Trails) was APPROVED BY THE WASHOE COUNTY PLANNING COMMISSION ON DATE.

THIS FINAL MAP, MAP NAME AND UNIT/PHASE #, MEETS ALL APPLICABLE STATUTES, ORDINANCES AND CODE PROVISIONS, IS IN SUBSTANTIAL CONFORMANCE WITH THE TENTATIVE MAP AND ITS CONDITIONS, WHICH ARE INCORPORATED HEREIN BY THIS REFERENCE, AND THOSE CONDITIONS HAVE BEEN SATISFIED FOR RECORDATION OF THIS MAP, EXCEPT THAT THE "OPERATIONAL CONDITIONS" CONTAINED IN THE RECORDED ACTION ORDER SHALL REMAIN IN FULL FORCE AND EFFECT IN PERPETUITY.

IF ALL LOTS ON THIS MAP ARE REVERTED TO ACREAGE AND A NEW SUBDIVISION APPROVAL IS OBTAINED AT A FUTURE DATE,

THE PROVISIONS OF THIS APPROVAL SHALL BE NULL AND VOID, UPON APPROVAL BY WASHOE COUNTY OF THOSE ACTIONS.

[Omit the following paragraph if this is the first and last (only) final map.]

THE NEXT FINAL MAP FOR TM14-002 MUST BE APPROVED AND ACCEPTED FOR RECORDATION BY THE PLANNING AND DEVELOPMENT DIRECTOR ON OR BEFORE THE EXPIRATION DATE, THE _____ DAY OF _____, 20____, OR AN EXTENSION OF TIME FOR THE TENTATIVE MAP MUST BE APPROVED BY THE WASHOE COUNTY PLANNING COMMISSION ON OR BEFORE SAID DATE.

THIS FINAL MAP IS APPROVED AND ACCEPTED FOR RECORDATION THIS _____ DAY OF _____, 20____ BY THE PLANNING AND DEVELOPMENT DIRECTOR. THE OFFER OF DEDICATION FOR STREETS, SEWERS, ETC. IS REJECTED AT THIS TIME, BUT WILL REMAIN OPEN IN ACCORDANCE WITH NRS CHAPTER 278.

WHILLIAM H. WHITNEY, DIRECTOR OF THE PLANNING AND DEVELOPMENT DIVISION

- i. The developer shall be required to participate in any applicable General Improvement District or Special Assessment District formed by Washoe County.
- j. A note shall be placed on all grading plans and construction drawings stating:

NOTE

Should any prehistoric or historic remains/artifacts be discovered during site development, work shall temporarily be halted at the specific site and the State Historic Preservation Office of the Department of Museums, Library and Arts shall be notified to record and photograph the site. The period of temporary delay shall be limited to a maximum of two (2) working days from the date of notification.

- k. The final map shall designate faults that have been active during the Holocene epoch of geological time, and the final map shall contain the following note:

NOTE

No habitable structures shall be located on a fault that has been active during the Holocene epoch of geological time.

- l. The developer shall provide written approval from the U.S. Postal Service concerning the installation and type of mail delivery facilities. The system, other than individual mailboxes, must be shown on the project construction plans and installed as part of the on-site improvements.

- m. The developer and all successors shall direct any potential purchaser of the site to meet with the Planning and Development Division to review conditions of approval prior to the final sale of the site. Any subsequent purchasers of the site shall notify the Planning and Development Division of the name, address, telephone number and contact person of the new purchaser within thirty (30) days of the final sale.
- n. The applicant shall submit complete construction plans and building permits shall be issued within two (2) years from the date of approval by Washoe County. The applicant shall complete construction within the time specified by the building permits. Compliance with this condition shall be determined by the Planning and Development Division.
- o. In the event that Regulatory Zone Amendment Case Number RZA14-004 (Autumn Trails) is not adopted by the Washoe County Commission, this tentative map will become null and void.
- p. The applicants shall remove the large dirt stockpile located at the northern terminus of Hayfield Drive with the first phase of the development.

Washoe County Engineering and Capital Projects Division

- 2. The following conditions are requirements of the Engineering and Capital Projects Division, which shall be responsible for determining compliance with these conditions.

Contact Name – Leo Vesely, 775.328.2040, lvesely@washoecounty.us

- a. Final maps and final construction drawings shall comply with all applicable statutes, ordinances, rules, regulations, and policies in effect at the time of submittal of the tentative map or, if requested by the developer and approved by the applicable agency, those in effect at the time of approval of the final map.
- b. Prior to acceptance of public improvements and release of any financial assurances, the developer shall furnish to the water and sewer provider(s) and Engineering Division a complete set of reproducible as-built construction drawings prepared by a civil engineer registered in the State of Nevada.
- c. The developer shall be required to participate in any applicable General Improvement District or Special Assessment District formed by Washoe County. The Engineering and Capital Projects Division shall be responsible for determining compliance with this condition.
- d. The developer shall provide written approval from the U.S. Postal Service concerning the installation and type of mail delivery facilities. The system, other than individual mailboxes, must be shown on the project construction plans and installed as part of the onsite improvements. The County Engineer shall determine compliance with this condition.
- e. All open space shall be identified as common area on the final map. A note on the final map shall indicate that all common areas shall be privately maintained and perpetually funded by the Homeowners Association. The County Engineer shall determine compliance with this condition. The maintenance of the common areas

shall also be addressed in the CC&Rs to the satisfaction of the District Attorney's Office.

- f. Any existing easements or utilities that conflict with the development shall be relocated, quitclaimed, and/or abandoned, as appropriate. The County Engineer shall determine compliance with this condition.
- g. Any easement documents recorded for the project shall include an exhibit map that shows the location and limits of the easement in relationship to the project. The County Engineer shall determine compliance with this condition.
- h. All existing overhead utility lines shall be placed underground, except electric transmission lines greater than 100 kilovolts, which can remain above ground. The County Engineer shall determine compliance with this condition.
- i. A complete set of construction improvement drawings, including an onsite grading plan, shall be submitted to the County Engineer for approval prior to finalization of any portion of the tentative map. Grading shall comply with best management practices (BMP's) and shall include detailed plans for grading and drainage for lots, project roadways, erosion control (including BMP locations and installation details), slope stabilization and mosquito abatement. A conceptual grading and drainage scheme shall be indicated for each lot on the grading plan. If drainage from one lot to another is proposed, then appropriate drainage easements shall be provided. Disposal of any excavated material onsite shall be indicated on the grading plans. The County Engineer shall determine compliance with this condition.
- j. A grading bond of \$2,000/acre of disturbed area shall be provided to the Engineering and Capital Projects Division prior to issuance of a grading permit.
- k. The conditional approval of this tentative map shall not be construed as final approval of the drainage facilities shown on the tentative map. Final approval of the drainage facilities will occur during the final map review and will be based upon the final hydrology report.
- l. Prior to finalization of any portion of the tentative map, a final, detailed hydrology/hydraulic report for that unit shall be submitted to the County Engineer. The hydrology/hydraulic report shall be consistent with the master drainage plan for Sky Ranch North Unit 2. All storm drainage improvements necessary to serve the project shall be designed and constructed to County standards and specifications and/or financial assurances in an appropriate form and amount shall be provided. The County Engineer shall determine compliance with this condition.
- m. Any increase in stormwater runoff resulting from development and base on the 100-year storm shall be detained. The County Engineer shall determine compliance with this condition.
- n. Standard reinforced concrete headwalls or other approved alternatives shall be placed on the inlet and outlet of all drainage structures, and grouted rock riprap shall be used to prevent erosion at the inlets and outlets of all culverts to the satisfaction of the Engineering and Capital Projects Division.

- o. The applicant shall provide pretreatment for petrochemicals and silt for all storm drainage from the site to the satisfaction of the County Engineer.
- p. The developer shall obtain a Stormwater Discharge Permit from the Nevada Division of Environmental Protection (NDEP), and a copy of the permit shall be submitted to the County Engineer. The Stormwater Pollution Prevention Plan shall be included with the subdivision improvement drawings.
- q. The Truckee Meadows Regional Stormwater Quality Management Program Construction Permit Submittal Checklist and Inspection Fee shall be submitted with each final map. The County Engineer shall determine compliance with this condition.
- r. Drainage swales that drain more than two lots are not allowed to flow over the curb into the street; these flows shall be intercepted by an acceptable storm drain inlet and routed into the storm drain system. The County Engineer shall determine compliance with this condition.
- s. A note on the final map shall indicate that all drainage facilities not maintained by Washoe County shall be privately maintained and perpetually funded by a homeowners association. The maintenance and funding of these drainage facilities shall also be addressed in the CC&Rs to the satisfaction of the District Attorney's Office. The County Engineer shall determine compliance with this condition.
- t. The maximum permissible flow velocity (that which does not cause scour) shall be determined for all proposed channels and open ditches. The determination shall be based on a geotechnical analysis of the channel soil, proposed channel lining and channel cross section, and it shall be in accordance with acceptable engineering publications/calculations. Appropriate linings shall be provided for all proposed channels and open ditches such that the 100-year flows do not exceed the maximum permissible flow velocity. The County Engineer shall determine compliance with this condition.
- u. All slopes steeper than 5:1 shall be stabilized to control erosion. The County Engineer shall determine compliance with this condition.
- v. Maintenance access and drainage easements shall be provided for all existing and proposed drainage facilities. The County Engineer shall determine compliance with this condition.
- w. Drainage easements shall be provided across individual lots on the official map for all storm runoff that crosses more than one lot. The County Engineer shall determine compliance with this condition.
- x. Common Area drainage onto residential lots shall be intercepted and routed to appropriate storm drainage facilities. The County Engineer shall determine compliance with this condition.
- y. All roadway improvements necessary to serve the project shall be designed and constructed to County standards and specifications and/or financial assurances in an appropriate form and amount shall be provided. The County Engineer shall determine compliance with this condition.

- z. Street names shall be reviewed and approved by the Regional Street Naming Coordinator.
- aa. Proposed landscaping and/or fencing along street rights-of-way and within median islands shall be designed to meet American Association of State Highway and Transportation Officials (AASHTO) sight distances and safety guidelines. No tree shall overhang the curb line of any public street. The County Engineer shall determine compliance with this condition.
- bb. Sidewalks shall be constructed in accordance with current Washoe County standards for street improvements.
- cc. For any utilities placed in existing County streets, the streets shall be repaired to the satisfaction of the County Engineer. At a minimum, this will require full depth removal and replacement of asphalt for half the street width, or replacement of non-woven pavement reinforcing fabric with a 2" asphalt overlay for half the street width. Type II slurry seal is required for the entire street width with either option. Full width street improvements may be required if the proposed utility location is too close to the centerline of the existing street.
- dd. Streetlights shall be constructed to Washoe County standards at locations to be determined at the final design stage. The County Engineer shall determine compliance with this condition.
- ee. AASHTO clear zones shall be determined for all streets adjacent to retaining walls or slopes steeper than 3:1. If a recoverable or traversable clear zone cannot be provided, an analysis to determine if barriers are warranted shall be submitted for approval. The County Engineer shall determine compliance with this condition.
- ff. Any retaining walls that are adjacent to, provide support for or retain soil from the County right-of-way shall be constructed of reinforced masonry block or reinforced concrete and designed by an engineer licensed in the State of Nevada. The County Engineer shall determine compliance with this condition.
- gg. An adequate easement for snow storage and signage shall be identified on the final plat. The County Engineer shall determine compliance with this condition.
- hh. In the event that the traffic volume exceeds 2000 ADT, as there exist homes between Omni Dr and Cordoba that have direct access to Sunset Springs Lane the applicant shall install traffic calming mitigation along this section of Sunset Springs Lane.

Washoe County Engineering and Capital Projects Division - Water Resources & TMWA

- 3. The following conditions are requirements of the Engineering and Capital Projects - Water Resources, which shall be responsible for determining compliance with these conditions.

Contact Name – Pam Parenti, 775.834-8037, pparenti@tmwa.com

- a. The developer must comply with all of TMWA water rights and infrastructure and connection fee requirements. Starting on November 4, 2014, all new development will go process with the TMWA new development group.

Washoe County Engineering and Capital Projects Division – Sewer Services

4. The following conditions are requirements of the Engineering and Capital Projects - Water Resources, which shall be responsible for determining compliance with these conditions.
 - a. The applicant's Engineer shall provide a sewer report to the DWR to ensure the proposed density increase by the land use change does not adversely affect any sewer infrastructure.
 - b. The applicant's Engineer shall coordinate the project regarding the City of Sparks' sewer interceptor and treatment plant facilities.

Washoe County Environmental Health District

5. The following conditions are requirements of the Health District , which shall be responsible for determining compliance with these conditions. The District Board of Health has jurisdiction over all public health matters in the Health District. Any conditions set by the Health District must be appealed to the District Board of Health.

Contact Name – Chris Anderson, 775.328.2632, canderson@washoecounty.us

- a. Grading and drainage shall not impact the adjacent on-site sewage disposal systems in the adjacent Bridal Path subdivision in any manner that would result in non-compliance of said on-site sewage disposal systems with the Washoe County District Board of Health Sewage, Wastewater and Sanitation regulations.
- b. Prior to any grading or other site improvements, a complete water system plan and Water Project submittal for the referenced proposal must be submitted to this Division. The plan must show that the water system will conform to the State of Nevada Public Water Supply Regulations, NAC Chapter 445A, and the State of Nevada Regulations Governing Review of Plans for Subdivisions, Condominiums, and Planned Unit Developments, NAC 278.400 and 278.410.
 - i) Two copies of all plans are required for review. All plans must include an overall site plan, additional phases that will eventually be built to indicate that the water system will be looped, all proposed grading, utilities, and improvements for the proposed application.
 - ii) Any construction activities (including but not limited to mass grading of the site) conducted prior to the review and approval of the required Water Project and submittal and approval of a Final Map are in violation of NAC 445A.6666, NAC 445A.6669, and NAC 278.340.
- c. Pursuant to NAC 278.340 of the State of Nevada Regulations Governing Review of plans for Subdivision, Condominiums, and Planned Unit Developments, no construction (including grading) shall be performed prior to the Washoe County Health District approval of the referenced Final Map.
- d. Grading shall be performed in compliance with current best management practices and mosquito-breeding sources must be eliminated within graded areas. a) Grading plans must be reviewed and approved by the Washoe County Health District Vector Borne-Disease Program.

- e. Construction plans for the development must be submitted to this Division for approval. The construction drawings must conform to the State of Nevada Regulations Concerning Review of Plans for Subdivisions, Condominiums and Planned Unit Developments, and any applicable requirements of the Washoe County Health District.
- f. Prior to approval of a Final Map for the referenced project and pursuant to NAC278.370, the design engineer is required to submit to the satisfaction this Division an inspection plan for periodic inspection of the construction of the systems for water supply and community sewerage. The design engineer shall, pursuant to the approved inspection plan, periodically certify in writing to the Division that the improvements are being installed in accordance with the approved plans and recognized practices of the trade. a) A copy of the inspection plan must be included with the Final Map submittal.
- g. Prior to final approval, a "Commitment for Service" letter from the sewage purveyor committing sewer service for the entire proposed development must be submitted to the Division. The letter must indicate that the community facility for treatment will not be caused to exceed its capacity and the discharge permit requirements by this added service, or the facility will be expanded to provide for the added service. a) A copy of this letter must be included with the Final Map submittal.
- h. Prior to final approval, a "Commitment for Water Service" letter from the water purveyor committing adequate water service for the entire proposed development must be submitted to the Division. a) A copy of this letter must be included with the Final Map submittal.
- i. The Final Map application packet must include a letter from Nevada Division of Environmental Protection to the Health District certifying their approval of the Final Map. a) A copy of this letter must be included with the final map submittal.
- j. Pursuant to NAC 278.360 of the State of Nevada Regulations Governing Review of plans for Subdivision, Condominiums, and Planned Unit Developments, the development of the subdivision must be carried on in a manner which will minimize water pollution.
- k. Prior to approval of the final map, the applicant must submit to this Division the Final Map fee.

Washoe County Health District – Vector Borne Diseases

- 6. The following conditions are requirements of the Health District – Vector Borne Diseases, which shall be responsible for determining compliance with these conditions. The District Board of Health has jurisdiction over all public health matters in the Health District. Any conditions set by the Health District must be appealed to the District Board of Health.

Contact Name – Jeff Jeppson, 775.785.4599, jjepson@washoecounty.us

- a. At a minimum the new storm water detention basin will require a rock lined low flow channel connecting the inlet and outlet pipe. A concrete low flow channel is preferred.

Washoe County Conditions of Approval

- b. The existing storm water detention basin currently has a rock lined low flow channel. If any changes are made to this basin the low flow channel should be protected, repaired, or replaced.
- c. A minimum 18 inch xeriscape catchment area will be required for the typical front lots between any turf grass and impervious surfaces. A 24 inch or greater catchment is preferred.

Truckee Meadows Fire Protection District

- 7. The following conditions are requirements of the Truckee Meadows Fire Protection District, which shall be responsible for determining compliance with these conditions.

Contact Name – Amy Ray, 775.326.6000, aray@washoecounty.us

- a. The CC&Rs/HOA regulations shall require that provisions be made to monitor, maintain and update, every three (3) years regardless of ownership, a maintenance plan for the common open space area. This plan shall be reviewed and approved by TMFPD.
- b. The maintenance of defensible space, dependent upon the fire hazard assessment rating, as designated by the *International Wildland Urban Interface Code* and the fire hazard map per NAC 472, shall be required.
- c. Additional language shall be provided to include approval of the required landscaping plan by TMFPD in compliance with the *International Wildland Urban Interface Code*.
- d. This development and all land and structures, shall meet the provisions of the WCC 60.

Washoe County School District

- 8. The following condition is a requirement of the Washoe County School District, which shall be responsible for determining compliance with these conditions.

Contact Name – Mike Boster, 775.789.3810, mobster@washoeschools.net

- a. A disclosure shall be made by the developer to each homebuyer on their closing documents that students in this subdivision may be assigned to the nearest school(s) with available capacity in the event that the zoned schools cannot accommodate additional students.

*** End of Conditions ***

Tentative Map For: Autumn Trails

GENERAL NOTES

- ALL DIMENSIONS ARE APPROXIMATE.
- ALL STREETS ARE TO BE PUBLIC UNLESS OTHERWISE NOTED.
- THIS SITE IS LOCATED IN FEMA FLOOD ZONE X WHICH IS DETERMINED TO BE OUTSIDE OF THE 100 YEAR FLOOD PLAIN.
- ALL CONSTRUCTION AND MATERIALS SHALL CONFORM TO THE STANDARD SPECIFICATIONS FOR PUBLIC WORKS CONSTRUCTION (SSPWC) AND THE STANDARD DETAILS FOR PUBLIC WORKS CONSTRUCTION (SDPWC), AS ADOPTED BY THE WASHOE COUNTY, AND SHALL BE SUBJECT TO THE APPROVAL OF THE OWNER. ALL SPECIFICATIONS REFERENCED HEREIN REFER TO THE SSPWC UNLESS INDICATED OTHERWISE.
- SHOULD ANY PREHISTORIC OR HISTORIC REMAINS/ARTIFACTS BE DISCOVERED DURING SITE DEVELOPMENT, WORK SHALL TEMPORARILY BE HALTED AT THE SPECIFIC SITE AND THE STATE HISTORIC PRESERVATION OFFICE OF THE DEPARTMENT OF MUSEUMS, LIBRARY AND ARTS, SHALL BE NOTIFIED TO RECORD AND PHOTOGRAPH THE SITE. THE PERIOD OF TEMPORARY DELAY SHALL BE LIMITED TO A MAXIMUM OF TWO (2) WORKING DAYS FROM THE DATE OF NOTIFICATION.

EROSION CONTROL NOTES

- THE TEMPORARY EROSION CONTROL MEASURES AS SHOWN ARE MINIMUM REQUIREMENTS. THE CONTRACTOR IS RESPONSIBLE FOR COORDINATING WITH THE ENGINEER TO PROVIDE ADDITIONAL MEASURES AS MAY BE NECESSARY DUE TO CONSTRUCTION PHASING AND TO COMPLY WITH STATE AND LOCAL REGULATIONS INCLUDING BEST MANAGEMENT PRACTICES. THE CONTRACTOR/ENGINEER SHALL SUBMIT A CONSTRUCTION PHASING PLAN FOR REVIEW AND APPROVAL PRIOR TO CONSTRUCTION.
- REFER TO STATE OF NEVADA CONSTRUCTION SITE BEST MANAGEMENT PRACTICES HANDBOOK FOR ALL BEST MANAGEMENT PRACTICES (BMP'S) TO BE UTILIZED DURING CONSTRUCTION.
- AT A MINIMUM, THE CONTRACTOR OR HIS AGENT SHALL INSPECT ALL DISTURBED AREAS, AREAS USED FOR STORAGE OF MATERIALS AND EQUIPMENT THAT ARE EXPOSED TO PRECIPITATION, VEHICLE ENTRANCE AND EXIT LOCATIONS AND ALL BMP'S WEEKLY, PRIOR TO A FORECASTED RAIN EVENT AND WITHIN 24 HOURS AFTER ANY ACTUAL RAIN EVENT. THE CONTRACTOR OR HIS AGENT SHALL UPDATE OR MODIFY THE STORMWATER POLLUTION PLAN AS NECESSARY. REFER TO STORMWATER GENERAL PERMIT NVR100000, SECTION 1.B.1.d.(2).
- THE DEVELOPER/OWNER SHALL MAINTAIN AND CLEAN ALL PRIVATE PERMANENT SEDIMENT CONTROL DEVICES AND DRAINAGE FACILITIES INCLUDING CATCH BASINS, SEDIMENT BASINS, DETENTION BASINS, DITCHES, SWALES, AND PIPING. THE DEVELOPER/OWNER SHALL INSPECT AND CLEAN DEVICES EVERY 6 MONTHS OR AFTER EACH STORM RUNOFF EVENT, WHICHEVER OCCURS FIRST.
- ACCUMULATED SEDIMENT IN BMP'S SHALL BE REMOVED AT REGULAR INTERVALS, WITHIN SEVEN DAYS AFTER A STORMWATER RUNOFF EVENT, AND PRIOR TO THE NEXT FORECASTED STORM EVENT. SEDIMENT MUST BE REMOVED WHEN BMP DESIGN CAPACITY HAS BEEN REDUCED BY 50 PERCENT OR MORE.
- THE OWNER, SITE DEVELOPER, CONTRACTOR AND/OR THEIR AUTHORIZED AGENTS SHALL EACH DAY REMOVE ALL SEDIMENT, MUD, CONSTRUCTION DEBRIS, OR OTHER POTENTIAL POLLUTANTS THAT MAY HAVE BEEN DISCHARGED TO, OR ACCUMULATE IN, THE PUBLIC RIGHT-OF-WAY AS A RESULT OF CONSTRUCTION ACTIVITIES ASSOCIATED WITH THIS SITE DEVELOPMENT OR CONSTRUCTION PROJECT. SUCH MATERIALS SHALL BE PREVENTED FROM ENTERING THE STORM WATER SYSTEM.
- ADDITIONAL CONSTRUCTION SITE DISCHARGE BEST MANAGEMENT PRACTICES MAY BE REQUIRED OF THE OWNER AND THEIR AGENTS DUE TO UNFORESEEN EROSION PROBLEMS OR IF THE SUBMITTED PLAN DOES NOT MEET THE PERFORMANCE STANDARDS SPECIFIED IN THE STATE OF NEVADA CONSTRUCTION SITE BEST MANAGEMENT PRACTICES HANDBOOK.
- ALL DRAINAGE SWALES WHERE RIPRAP IS NOT REQUIRED SHALL BE REVEGETATED WITH SEED MIXTURE AS SHOWN IN THE REVEGETATION NOTES.
- MECHANICAL SLOPE STABILIZATION FOR SLOPES: UNLESS NOTED OTHERWISE, SLOPES GREATER THAN 3:1 SHALL BE STABILIZED WITH RIPRAP. SWALES AND V-DITCHES SHALL BE RIP RAPPED AS SPECIFIED ON PLANS. THE ROCK SHALL CONTAIN A MINIMUM OF FOUR FRACTURED FACES AND BE PLACED TO A MINIMUM DEPTH OF 12 INCHES. A MINIMUM OF 75% OF THE RIPRAP SHALL BE THE SPECIFIED ROCK DIAMETER OR GREATER.
- STABILIZE CONSTRUCTION ENTRANCES AND EQUIPMENT PARKING AREAS WITH GRAVEL PRIOR TO GRADING.
- INSTALL PRINCIPAL BASINS AND SEDIMENT BARRIERS BEFORE GRADING OCCURS. AFTER CONSTRUCTION, REMOVE ACCUMULATED DEBRIS IN THE SEDIMENT BARRIERS TO PREVENT EROSION.
- BEFORE CONSTRUCTION BEGINS, INSTALL SILT CONTROL DEVICES AT STORM DRAIN INLETS RECEIVING RUNOFF FROM THE SITE AND MAINTAIN THEM DURING CONSTRUCTION.
- WHEN THE WORK, INCLUDING REVEGETATION, HAS BEEN COMPLETED, THE TEMPORARY EROSION CONTROL MEASURES SHALL BE REMOVED.

REVEGETATION NOTES

- REVEGETATION: ALL AREAS DISTURBED AND LEFT UNDEVELOPED FOR A PERIOD OF MORE THAN THIRTY (30) DAYS SHALL BE STABILIZED BY THE APPLICATION OF DUST PALLIATIVE AND, IF LEFT MORE THAN NINETY (90) DAYS, PLANTED AS FOLLOWS:
 - DISTURBED AREAS AND SLOPES 3:1 AND FLATTER SHALL BE REVEGETATED BY EITHER HYDROSEEDING/HYDROMULCHING (TWO STEP PROCESS) OR ROADCAST SEEDING AND HYDROMULCHING (AT CONTRACTORS OPTION, IN LIEU OF HYDROMULCHING, STRAW, IN COMBINATION WITH TACKIFIER, MAY BE USED).
 - THE TOP 6 INCHES OF TOPSOIL AND PLANT MATERIAL DISTURBED DURING GRADING OPERATIONS SHALL BE SALVAGED AND STOCKPILED ON-SITE. THE CONTRACTOR SHALL PROTECT THE STOCKPILE UNTIL RE-APPLICATION, INCLUDING WATERING AND/OR APPLICATION OF MULCH OR TACKIFIERS.
 - THE SEED BED SHALL BE LOOSENEED TO A DEPTH OF 6 INCHES AND THE SALVAGED TOPSOIL RE-APPLIED AFTER SLOPES ARE FORMED. INCORPORATE THE TOPSOIL BY TILLING TWO LONGITUDINAL AND TWO PERPENDICULAR PASSES. PRIOR TO SEEDING, RUN A SPRING-TOOTHED HARROW PARALLEL TO THE SLOPE OR IN BOTH DIRECTIONS ON FLAT AREAS. MIX THE SEED WITH ONE THIRD OF HYDROMULCH MATERIAL AND APPLY PER THE LISTED RATES, FOLLOWED BY THE APPLICATION OF THE REMAINING TWO-THIRDS OF THE HYDROMULCH. INCORPORATE A SLOW RELEASE 16-20-0 FERTILIZER INTO THE HYDROMULCH AT A RATE OF 300 POUNDS PER ACRE.
 - ON TOP OF THE HYDROMULCH APPLY A TACKIFIER AT 130 POUNDS PER ACRE. THE MATERIAL SHALL BE AN ORGANIC, PLANT-DERIVED SUBSTANCE CONTAINING PSYLLIUM OR GUARGUM. THE MATERIAL SHALL FORM A TRANSPARENT FILM LIKE CRUST AND SHALL NOT BE DISTURBED WITH ANY TRAFFIC. AT THE CONTRACTOR'S OPTION, HE CAN USE A STRAW MULCH AND TACKIFIER INSTEAD OF HYDROMULCH. THE STRAW SHALL BE FREE FROM NOXIOUS WEEDS AND BE CLEAN BALES OF WHEAT, BARLEY, OAT, OR RICE. THE STRAW SHALL BE PUNCHED INTO THE SOIL MECHANICALLY AFTER AN APPLICATION RATE OF 2 TONS/ACRE WITH A STRAW BLOWER.
 - THE SEED SHALL BE LISTED WITH A PURE LIVE SEED CONTENT WITH WEED SEEDS NOT EXCEEDING 0.5 PERCENT OF THE PURE LIVE SEED AND INERT MATERIAL.
 - SEED MIX:

PLS POUNDS PER ACRE	SEED TYPE
5 LBS	INTERMEDIATE WHEATGRASS - AGROPYRON INTERMEDIUM
5 LBS	CRESTED WHEATGRASS - AGROPYRON CRISTATUM
2 LBS	BITTERBRUSH - PURSHIA TRIDENTATA
2 LBS	BIG SAGE - ARTEMESIA TRIDENTATA
1 LB	FOUR WING SALTBRUSH - ATRIPLEX CANESCENS
1 LB	RABBITBRUSH - CHRYSOETHAMNUS NAUSEOSUS
1 LB	YARROW - ACHILLEA MILLIFOLIUM
2 LBS	CALIFORNIA POPPY - ESHSCHOLTZIA CALIFORNICA
5 LBS	INDIAN RICEGRASS - ORYZOPHYS HYMENOIDES
24 LBS	TOTAL POUNDS PER ACRE, PLS
- THE CONTRACTOR OR DEVELOPER SHALL SUPPLEMENT RAINFALL, IF NECESSARY, WITH ADEQUATE TEMPORARY IRRIGATION OF RESEEDED AREAS UNTIL PLANTING HAS GERMINATED AND IS THRIVING TO A MINIMUM HEIGHT OF 4 INCHES. ANY AREAS THAT DO NOT SUCCESSFULLY GERMINATE IN THE OPINION OF THE ENGINEER OR THE COUNTY, ARE TO BE RESEEDED AND IRRIGATED UNTIL COVERED WITH VEGETATION. NO WATER TRUCKS WILL BE ALLOWED TO SPRAY THE SLOPES FOR IRRIGATION. A TEMPORARY IRRIGATION PLAN SHALL BE SUBMITTED FOR APPROVAL 30 DAYS PRIOR TO IMPLEMENTATION.

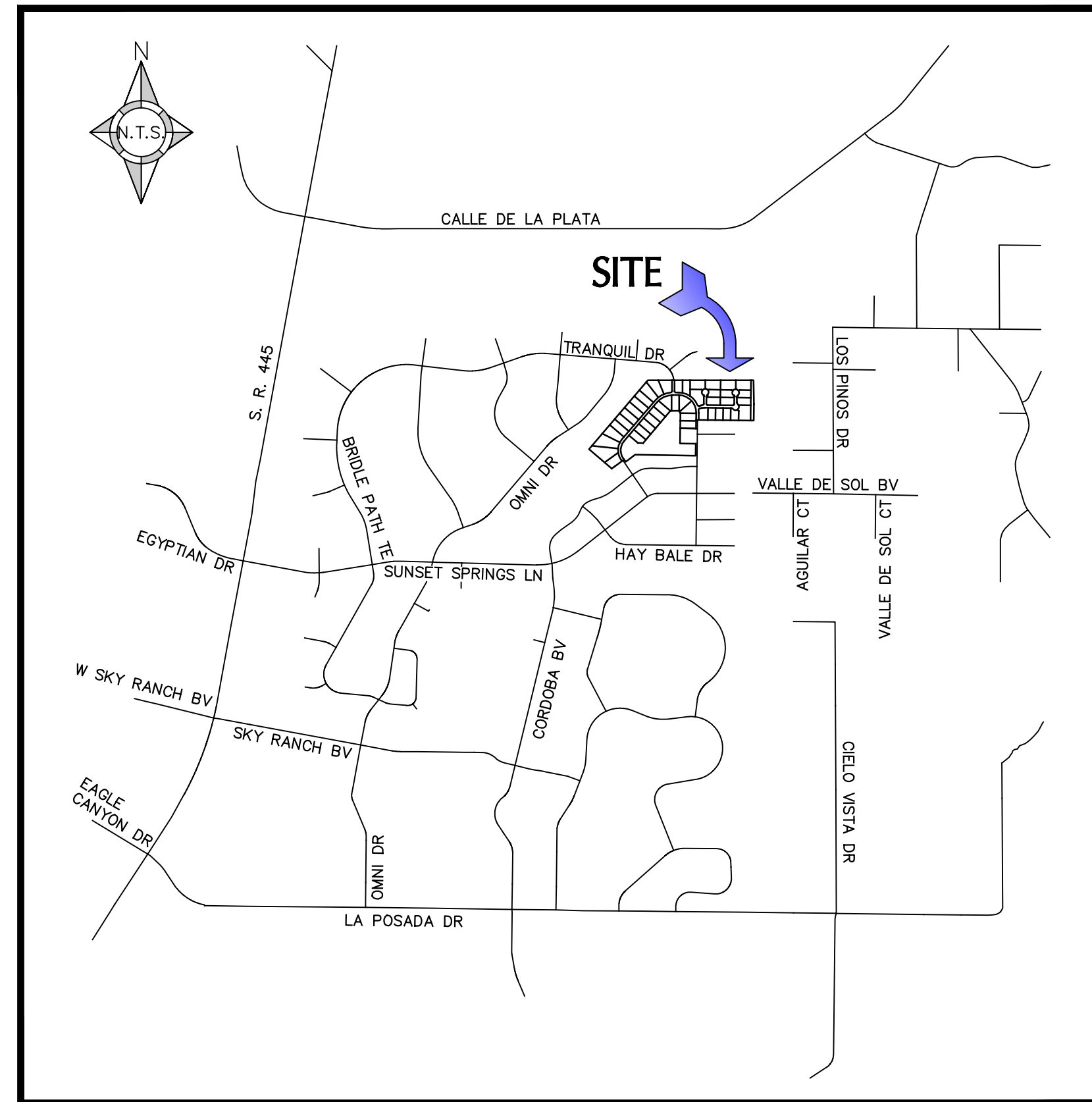

Vicinity Map

SCALE: N.T.S.

Development Statistics

PARCEL AREA = 47.608 AC
 ZONING = LDS (COMMON OPEN SPACE DEVELOPMENT)
 PROPOSED DENSITY = 0.90 DU/AC (43 UNITS)
 SINGLE FAMILY RESIDENTIAL = 31.56 AC
 RIGHT-OF-WAY = 3.68 AC
 COMMON AREA = 12.37 AC
 AVERAGE LOT SIZE = 31,971 S.F.
 LARGEST LOT = 58,393 S.F.
 SMALLEST LOT = 21,451 S.F.

Grading Statistics

DISTURBED AREA = 37.82 AC
 PROPOSED CUT = 108,800 YDS³
 PROPOSED FILL = 108,800 YDS³
 NET EARTHWORK = BALANCED
 MAXIMUM SLOPE = 3H:1V

Sheet Index

- | | |
|-----|---------------------------------------|
| C-1 | TITLE SHEET |
| C-2 | SITE GEOMETRIC PLAN |
| C-3 | SITE GRADING, DRAINAGE & UTILITY PLAN |
| C-4 | SITE GRADING, DRAINAGE & UTILITY PLAN |
| C-5 | SITE SECTIONS |

Owner

PINNACLE LAND HOLDINGS LLC
 ATTN: MICHAEL FIORE
 477 E 9TH ST
 RENO, NV 89512
 (775)682-4388

Civil Engineer

K2 ENGINEERING AND STRUCTURAL DESIGN
 3100 MILL STREET, SUITE 107
 RENO, NEVADA 89502
 (775)355-0505

Basis of Bearing

NAD83/94, NEVADA STATE
 PLANE COORDINATE SYSTEM
 WEST ZONE GRID

Basis of Elevation

NAVD 1988 WITH THE P.I. MONUMENT OF
 TRANQUIL DRIVE AND GEALDINE COURT
 TAKEN AS 4646.02' ABOVE MEAN SEA LEVEL

Utilities

WATER - WASHOE COUNTY DWR
 SEWER - WASHOE COUNTY DWR
 NATURAL GAS - NV ENERGY
 ELECTRIC - NV ENERGY
 TELEPHONE - AT&T
 CABLE TELEVISION - CHARTER COMMUNICATIONS
 SOLID WASTE - WASTE MANAGEMENT

Engineer's Statement

I, BRANDT T. KENNEDY, DO HERE BY CERTIFY THAT THESE IMPROVEMENT PLANS HAVE BEEN COMPLETED BY ME, OR UNDER MY SUPERVISION AND ARE IN COMPLIANCE WITH ALL APPLICABLE PROVISIONS SET FORTH BY THE WASHOE COUNTY DEVELOPMENT CODE AND THE STATE OF NEVADA REVISED STATUTES.

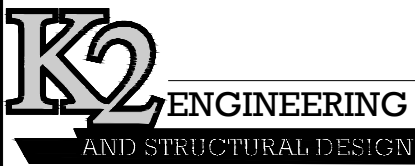

3100 Mill Street, # 107
 Reno, NV 89502
 P: (775) 355-0505
 F: (775) 355-0566
 www.K2eng.net

Autumn Trails Tentative Map
 Washoe County,
 Nevada
 0 Hayfield Drive
 APN: 534-420-08

Brandt T. Kennedy, P.E.
 Jared A. Krupa, P.E.

Revisions

△
 △
 △

Date	9/15/14
Drawn	K2
Checked	JAK
Project No.	14-166

Title Sheet

C-1

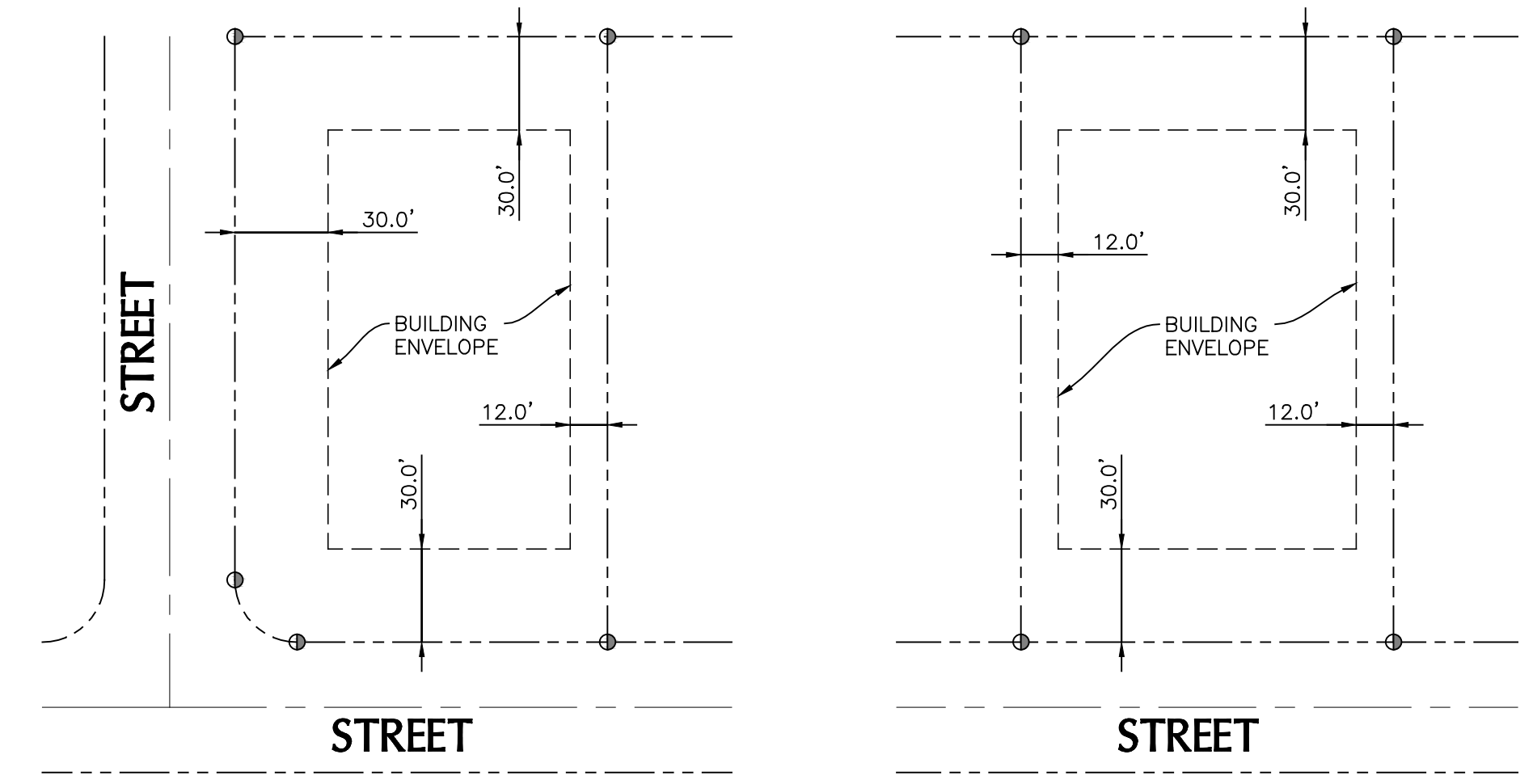
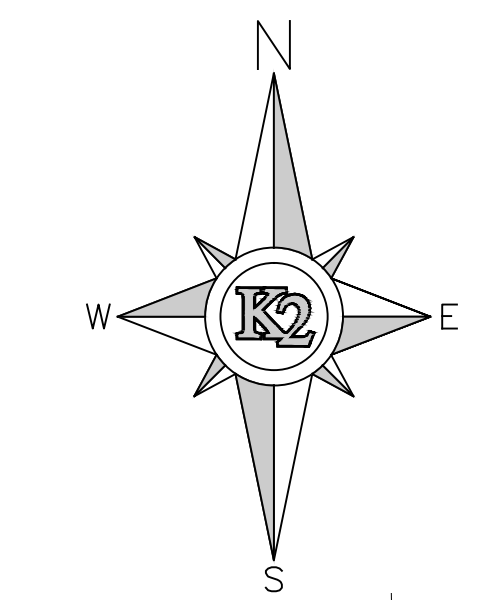
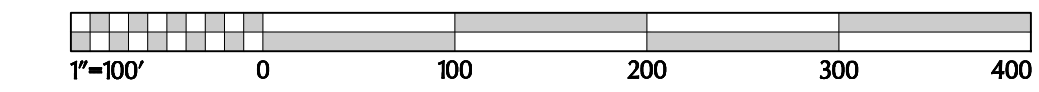

TYPICAL LOT SETBACKS

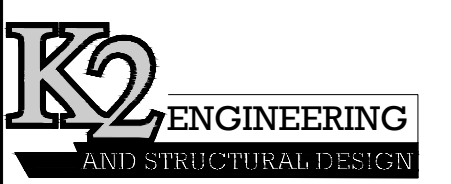
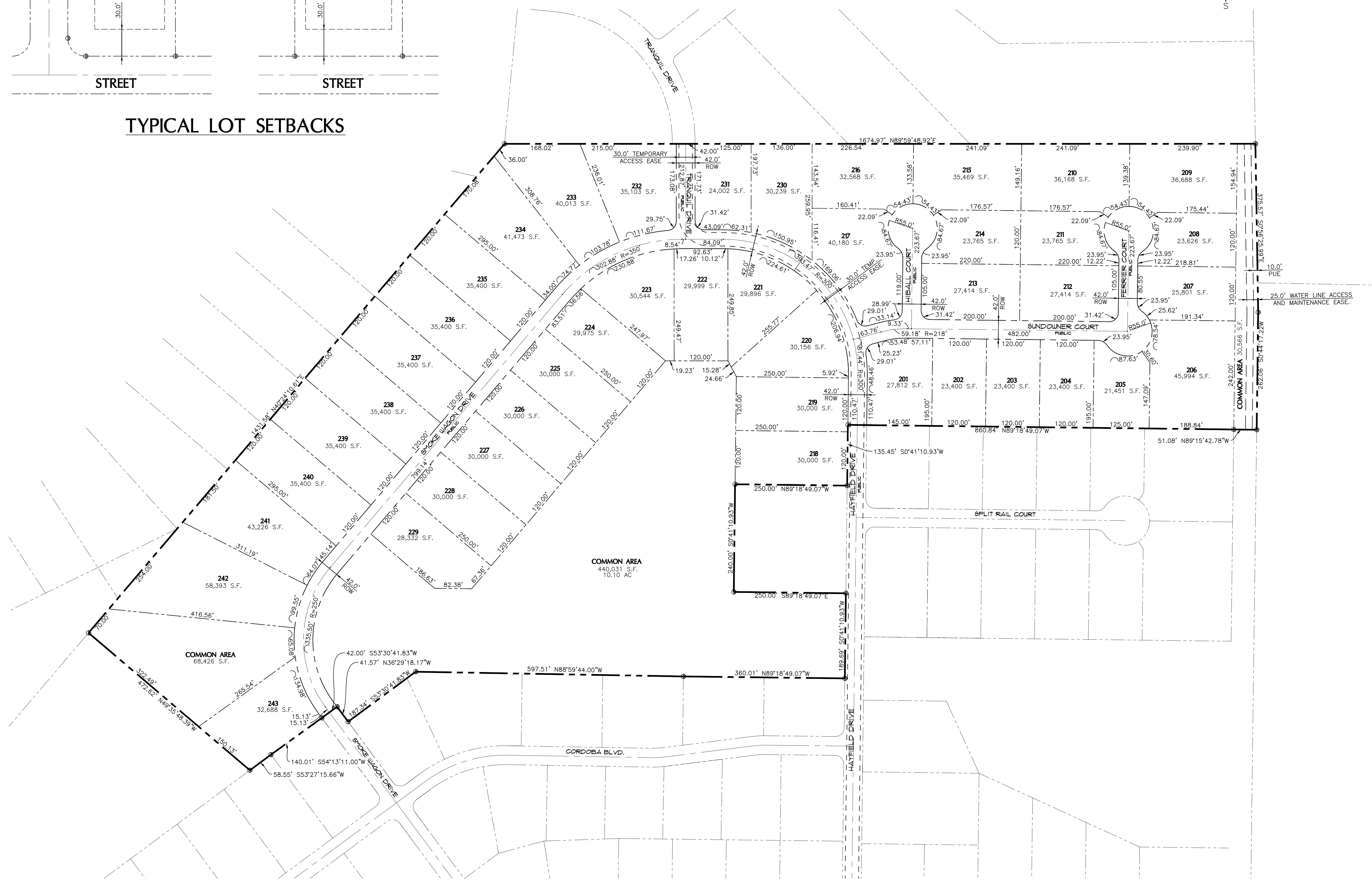

3100 Mill Street, # 107
 Reno, NV 89502
 P: (775) 355-0505
 F: (775) 355-0566
 www.K2eng.net

Autumn Trails Tentative Map
 Washoe County,
 Nevada
 0 Hayfield Drive
 APN: 534-420-08

Brandt T. Kennedy, P.E.
 Jared A. Krupa, P.E.

Revisions

▲	
▲	
▲	

Date 9/15/14
 Drawn K2
 Checked JAK
 Project No. 14-166

Site
 Geometric
 Plan

C-2

Autumn Trails Tentative Map
Washoe County,
Nevada
0 Hayfield Drive
APN: 534-420-08

Brandt T. Kennedy, P.E.
Jared A. Krupa, P.E.

Revisions

Date 9/15/14
Drawn K2
Checked JAK
Project No. 14-166

**Site Grading
Drainage &
Utility Plan**

C-3

TM14-002
EXHIBIT B

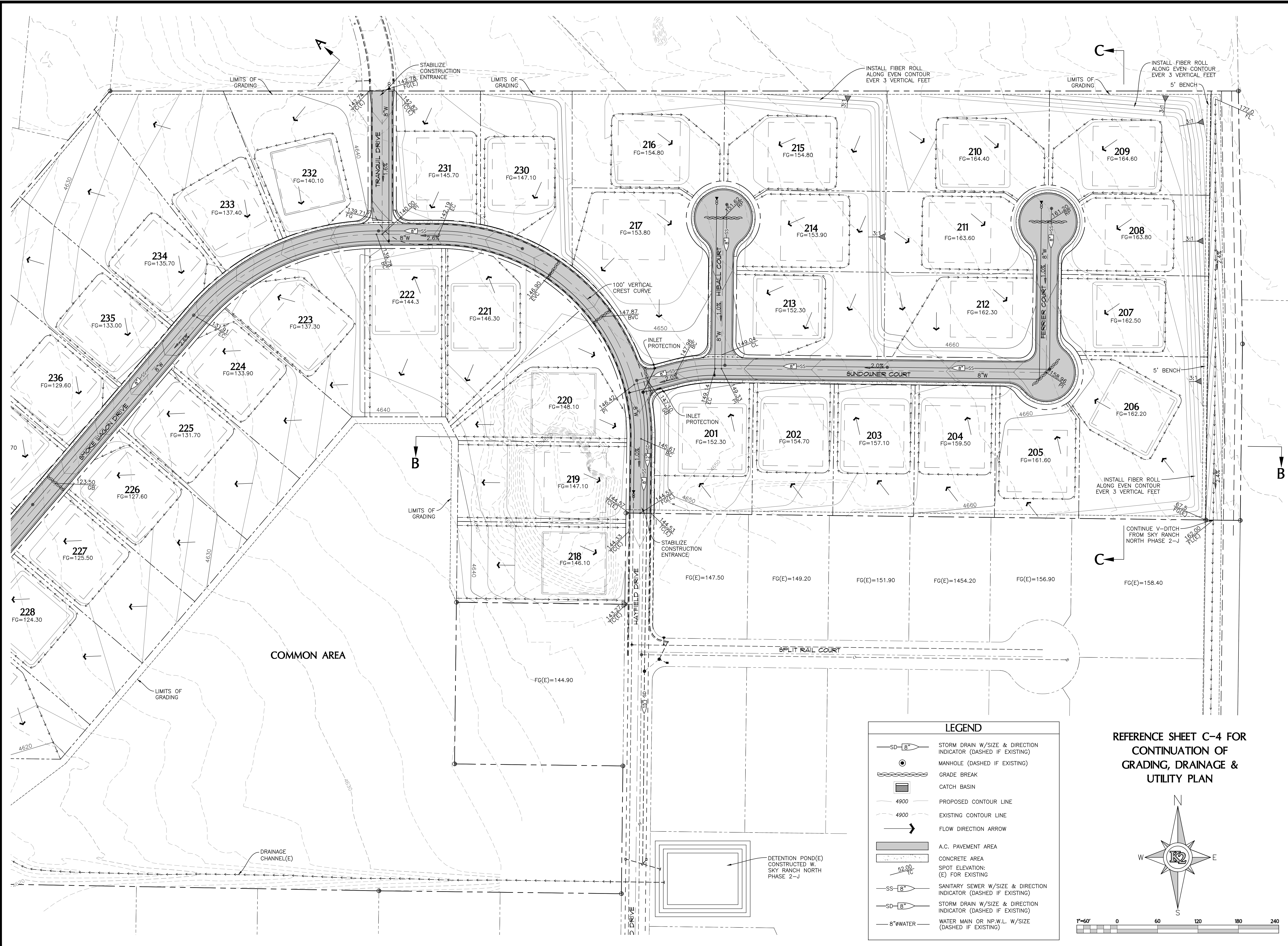

LEGEND

SD-8"	STORM DRAIN W/SIZE & DIRECTION INDICATOR (DASHED IF EXISTING)
○	MANHOLE (DASHED IF EXISTING)
— —	GRADE BREAK
■	CATCH BASIN
4900	PROPOSED CONTOUR LINE
4900	EXISTING CONTOUR LINE
→	FLOW DIRECTION ARROW
■	A.C. PAVEMENT AREA
■	CONCRETE AREA
52.00	SPOT ELEVATION: (E) FOR EXISTING
SS-8"	SANITARY SEWER W/SIZE & DIRECTION INDICATOR (DASHED IF EXISTING)
SD-8"	STORM DRAIN W/SIZE & DIRECTION INDICATOR (DASHED IF EXISTING)
8" WATER	WATER MAIN OR N.P.W.L. W/SIZE (DASHED IF EXISTING)

REFERENCE SHEET C-4 FOR
CONTINUATION OF
GRADING, DRAINAGE &
UTILITY PLAN

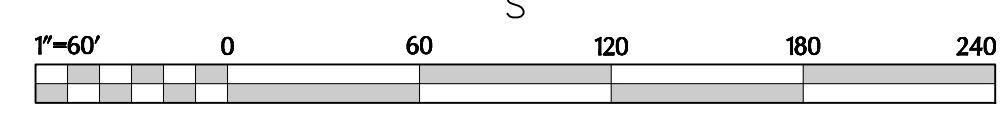
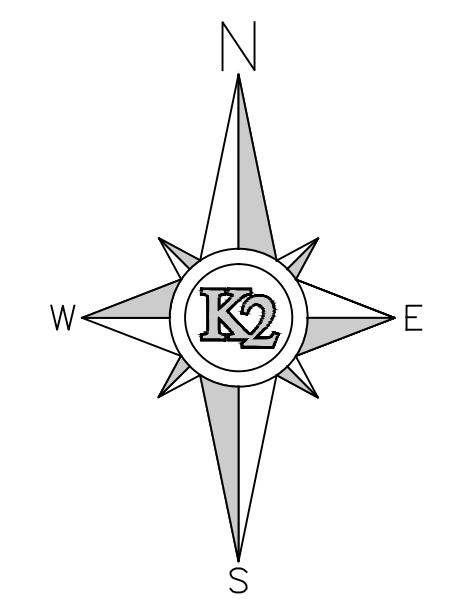

LEGEND

- STORM DRAIN W/SIZE & DIRECTION INDICATOR (DASHED IF EXISTING)
- MANHOLE (DASHED IF EXISTING)
- GRADE BREAK
- CATCH BASIN
- 4900 PROPOSED CONTOUR LINE
- 4900 EXISTING CONTOUR LINE
- FLOW DIRECTION ARROW
- A.C. PAVEMENT AREA
- CONCRETE AREA
- SPOT ELEVATION: (E) FOR EXISTING
- SS-8" SANITARY SEWER W/SIZE & DIRECTION INDICATOR (DASHED IF EXISTING)
- SD-8" STORM DRAIN W/SIZE & DIRECTION INDICATOR (DASHED IF EXISTING)
- 8" WATER MAIN OR NP.W.L. W/SIZE (DASHED IF EXISTING)

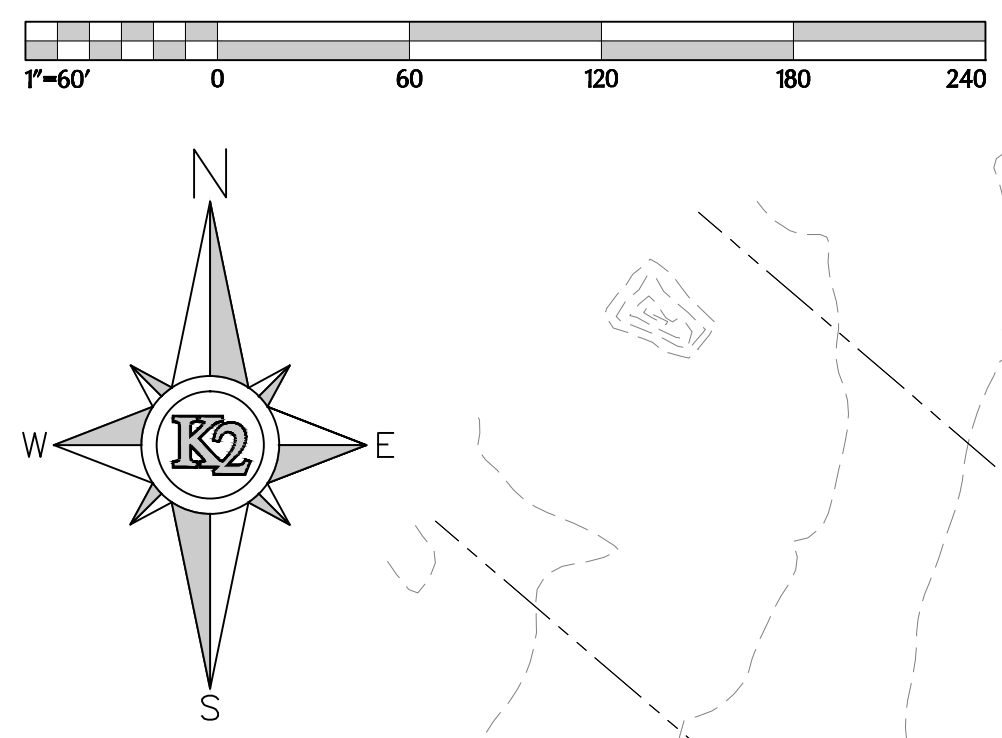

REFERENCE SHEET C-3 FOR CONTINUATION OF GRADING, DRAINAGE & UTILITY PLAN

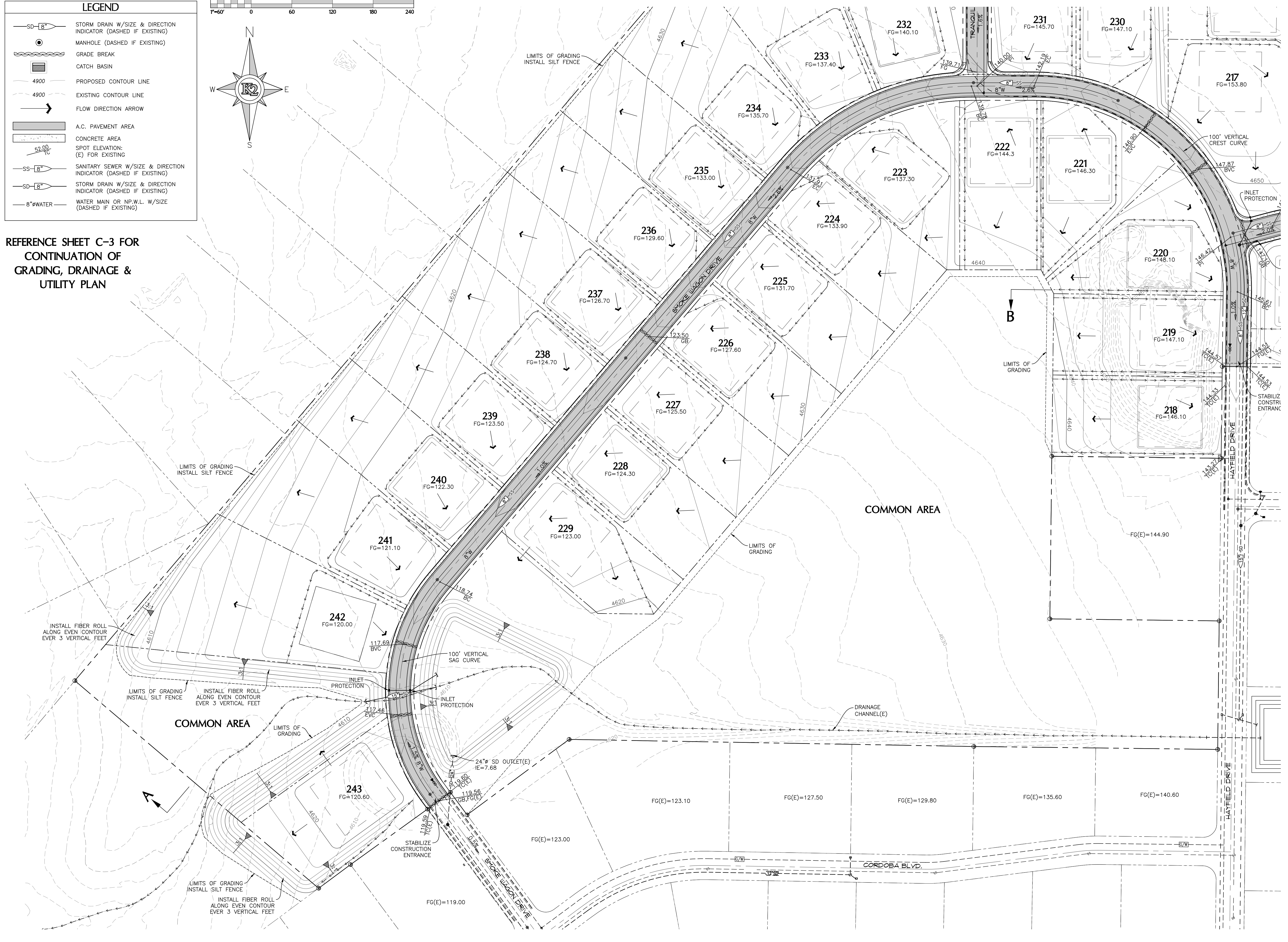

K2 ENGINEERING
AND STRUCTURAL DESIGN

3100 Mill Street, # 107
Reno, NV 89502
P: (775) 355-0505
F: (775) 355-0566
www.K2eng.net

Autumn Trails Tentative Map
 Washoe County,
 Nevada
 0 Hayfield Drive
 APN: 534-420-08

Brandt T. Kennedy, P.E.
Jared A. Krupa, P.E.

Revisions

No.	Description	Date

Date 9/15/14
 Drawn K2
 Checked JAK
 Project No. 14-166

Site Grading,
 Drainage &
 Utility Plan

C-4

SECTION 110.436.25-2: ROADWAY SECTIONS - B
 GENERAL APPLICATIONS: URBAN AREAS, SUBURBAN AREAS, LOT SIZES LESS THAN 0.5 AC.

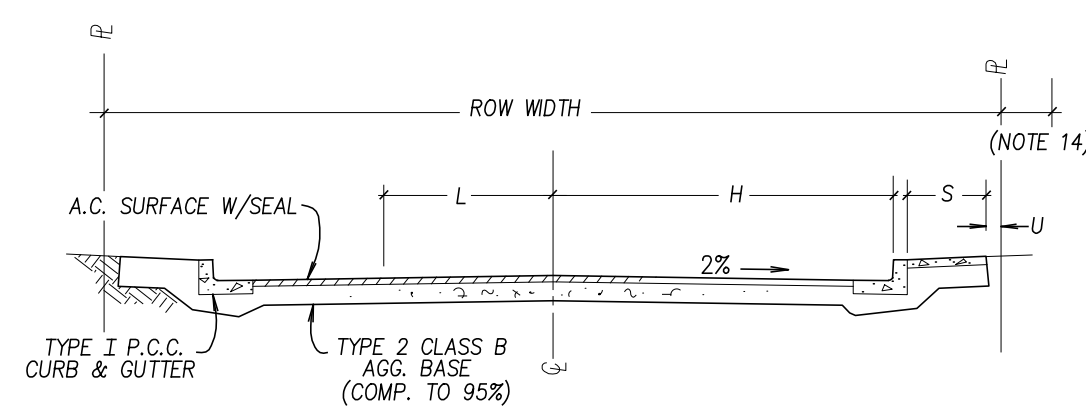

ROW	H	S	U	L	B	PL	ADT	MAX PER 2 TRAVEL LANES	REMARKS
52	20	5	0.5	12	4	0		7300	COLLECTOR
42	16	4	0.5	11	0	2		1000	LOCAL

NOTES

- ALL WIDTHS ARE IN FEET.
- H IS MEASURED TO THE FRONT FACE OF CURB.
- L IS TRAVEL LANE; S IS SIDEWALK; B IS BICYCLE LANE; PL IS MAX. NUMBER OF PARKING LANES ALLOWED; ROW IS RIGHT OF WAY; ADT IS AVERAGE DAILY TRAFFIC.
- ADT REPRESENTS THE DESIGN VOLUME FOR A TWO LANE FACILITY.
- BICYCLE LANE SHALL BE PROVIDED IN ACCORDANCE W/ THE BICYCLE AND PEDESTRIAN ELEMENT OF THE REGIONAL TRANSPORTATION PLAN AND TO THE SATISFACTION OF THE COUNTY ENGINEER.
- STRUCTURAL SECTIONS SHALL BE DETERMINED BY GEOTECHNICAL ENGINEERING DESIGN BUT IN NO CASE SHALL BE LESS THAN 4" A.C. OVER 6" GRAVEL BASE FOR COLLECTOR STREETS AND 3" A.C. OVER 6" GRAVEL BASE FOR LOCAL STREETS.
- ALL CURB AND GUTTER IS MONOLITHIC CONC. AND L SHAPED PER STANDARD DETAIL.
- SIDEWALK AREA IS CONC. BOTH SIDES FOR COLLECTORS, ONE SIDE FOR LOCALS. ALTERNATE SIDEWALK LOCATIONS/CONFIGURATIONS MUST BE APPROVED BY THE COUNTY ENGINEER.
- ALL A.C. SURFACES SHALL BE SEALED IN ACCORDANCE WITH WASHOE CO. STANDARDS.
- RESIDENTIAL DRIVEWAY ACCESS NOT ALLOWED TO STREETS ON WHICH 10YR. DESIGN ADT EXCEEDS 2000.
- DESIGN OF IMPROVEMENTS TO BE DONE IN ACCORDANCE WITH ARTICLES 420 & 436 OF WASHOE COUNTY DEVELOPMENT STANDARDS AND DESIGN GUIDELINES.
- ALL CONSTRUCTION IS TO BE DONE TO CURRENT WASHOE CO. STANDARDS & SPECIFICATIONS.
- SLOPE EASEMENTS MAY BE REQ'D IN CERTAIN TERRAIN TO ACCOMMODATE THE ROADWAY SECTION.
- MIN. 7.5' PUBLIC UTILITY/TRAFFIC CONTROL SIGNAGE/PLOWED SNOW EASEMENT IS REQ'D ON BOTH SIDES OF ROW.

NO.	REVISED	DATE	STANDARD DETAILS FOR PUBLIC WORKS CONSTRUCTION	SECTION:
6	changed odt	12/05sw	ROADWAY SECTIONS (B) GENERAL APPLICATIONS URBAN AREAS/SUBURBAN AREAS LOT SIZE: LESS THAN 0.5 ACRE	WASHOE
3	Sub/Notes	1/94sp		DRAWING NO: W-1.2
4	Corr "U"	2/94/sp		DATE: 2/93sp
5	Swg As W-2.dwg	10/01sp		PAGE: 2

PROPOSED STREET SECTION

ABBREVIATIONS

AC	- ASPHALT CONCRETE	MH	- MANHOLE
AGG	- AGGREGATE	MIN	- MINIMUM
BC	- BEGIN CURVE	MISC	- MISCELLANEOUS
BFC	- BACK FACE OF CURB	NPWL	- NON POTABLE WATER LINE
BVC	- BEGIN VERTICAL CURVE	NTS	- NOT TO SCALE
BW	- BOTTOM OF WALL	OD	- OUTSIDE DIAMETER
CL&	- CENTERLINE	P	- PROPOSED
CB	- CATCH BASIN	PAD	- PAD GRADE
CFS	- CUBIC FEET PER SECOND	PCC	- PORTLAND CEMENT CONCRETE
CO	- CLEAN OUT	PI	- POINT OF INTERSECTION
CONC	- CONCRETE	PIV	- POST INDICATOR VALVE
CONST	- CONSTRUCT	PL&	- PROPERTY LINE
COORD	- COORDINATE	PO	- PUSH ON
DET	- DETAIL	PRC	- POINT OF REVERSE CURVATURE
DI	- DROP INLET	PUE	- PUBLIC UTILITY EASEMENT
DOM	- DOMESTIC	PVC	- POLYVINYL CHLORIDE
E	- EXISTING	PVI	- POINT OF VERTICAL INTERSECTION
EC	- END CURVE	Q ₅	- FIVE YEAR FLOW RATE
ELEV	- ELEVATION	Q ₁₀₀	- ONE HUNDRED YEAR FLOW RATE
EVC	- END VERTICAL CURVE	Q _{cap}	- CAPACITY FLOW RATE
FDC	- FIRE DEPARTMENT CONNECTION	R	- RADIUS
FF	- FINISHED FLOOR ELEVATION	REF	- REFERENCE
FFC	- FRONT FACE OF CURB	RP	- RADIUS POINT
FG	- FINISHED GRADE	RT	- RIGHT
FH	- FIRE HYDRANT	RW	- RIGHT-OF-WAY
FL&	- FLOW LINE	S	- SLOPE
FLG	- FLANGE	SCH	- SCHEDULE
FT	- FOOT	SD	- STORM DRAIN
GB	- GRADE BREAK	SF	- SQUARE FOOT
GV	- GATE VALVE	SS	- SANITARY SEWER
HC	- HANDICAPPED	STA	- STATION
HP	- HIGH POINT	STD	- STANDARD
IE	- INVERT ELEVATION	SW	- SIDEWALK
IN	- INCH	T	- TANGENT
INT	- INTERSECTION	TB	- THRUST BLOCK
IRR	- IRRIGATION	TC	- TOP OF CURB
L	- LENGTH	TOE	- TOE OF SLOPE
LAT	- LATERAL	TOP	- TOP OF SLOPE
LF	- LINEAR FEET	TW	- TOP OF WALL
LP	- LOW POINT	TYP	- TYPICAL
LT	- LEFT	V	- VELOCITY
MAX	- MAXIMUM	W	- WATER
MDD	- MAXIMUM DRY DENSITY	YD	- YARD

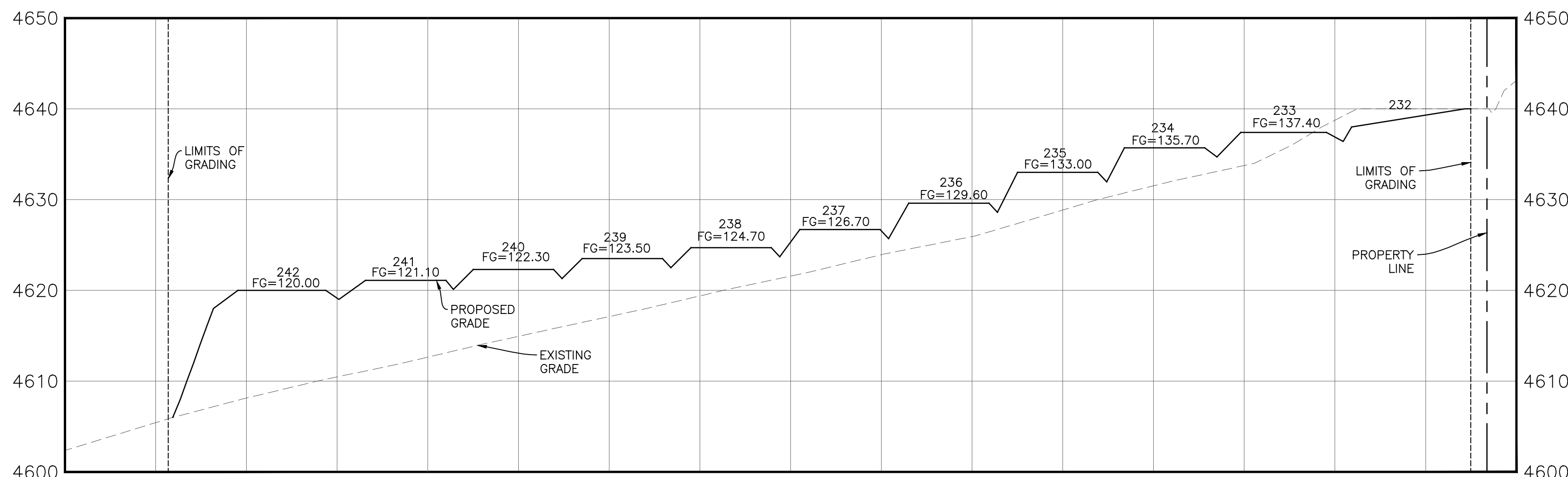

CROSS SECTION A-A

HORIZONTAL SCALE: 1"=100'
 VERTICAL SCALE: 1"=10'

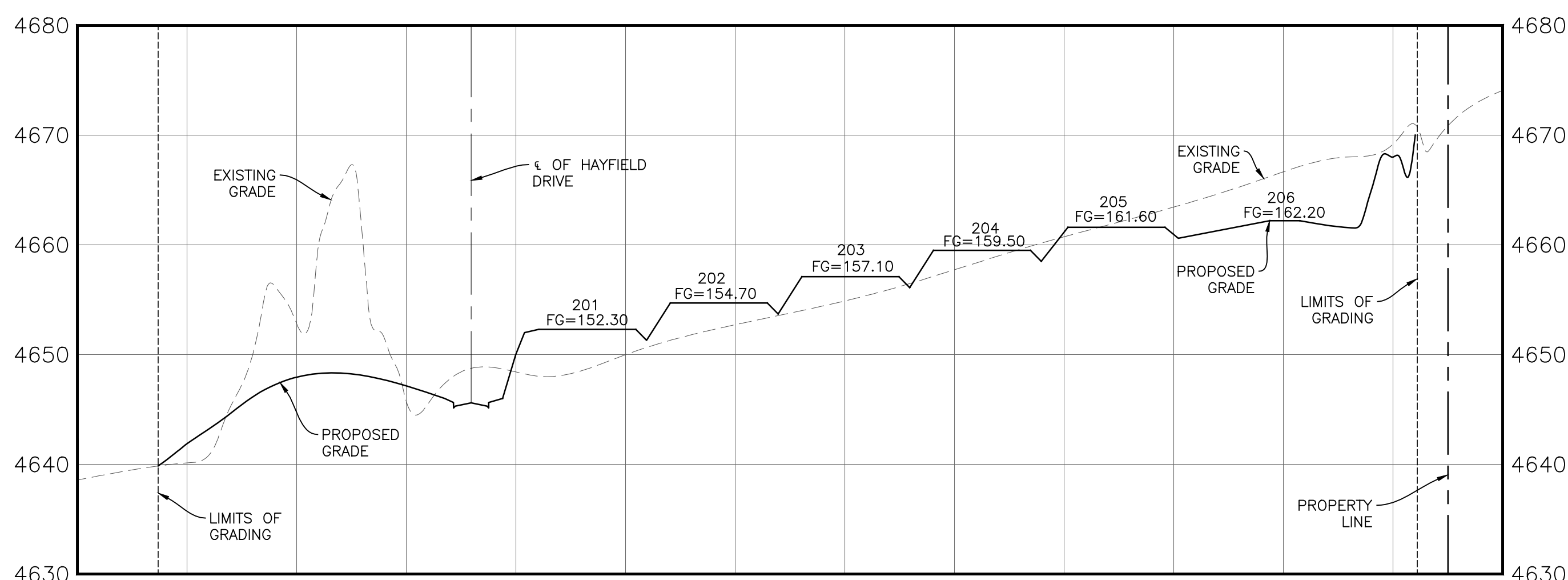

CROSS SECTION B-B

HORIZONTAL SCALE: 1"=100'
 VERTICAL SCALE: 1"=10'

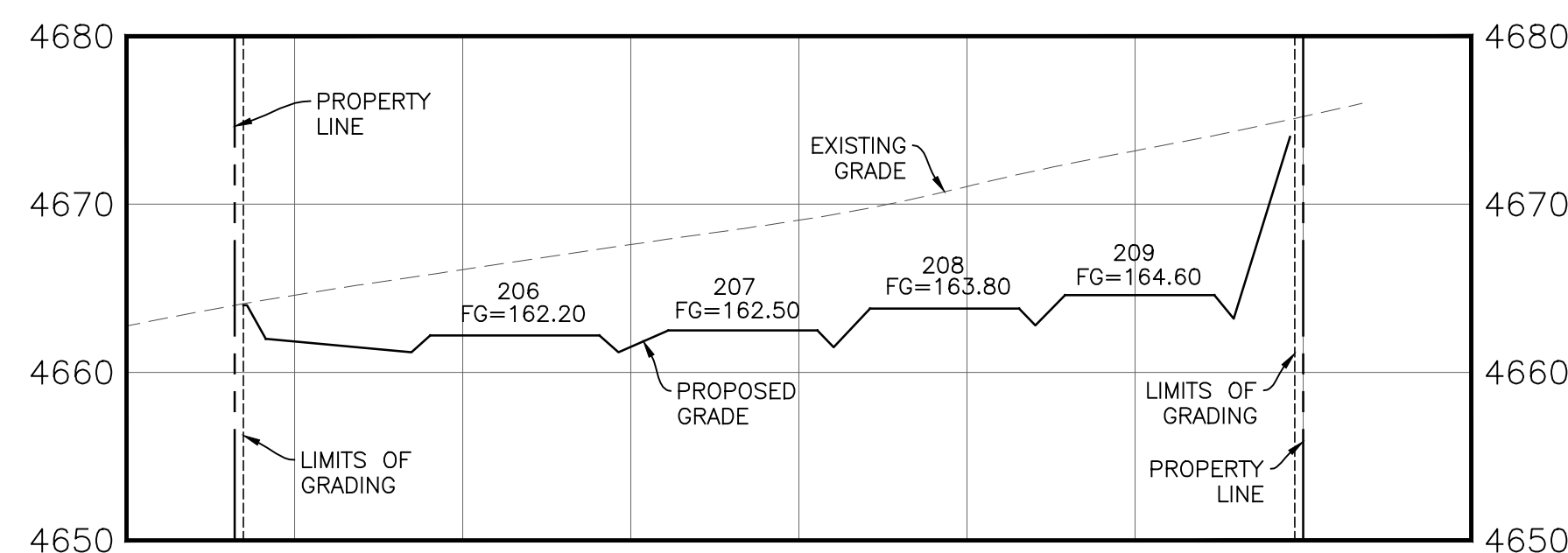

CROSS SECTION C-C

HORIZONTAL SCALE: 1"=100'
 VERTICAL SCALE: 1"=10'

Revisions

△	
△	
△	
△	
Date	9/15/14
Drawn	K2
Checked	JAK
Project No.	14-166

Site Sections



Spanish Springs Citizen Advisory Board

MEMORANDUM

To: Trevor Lloyd, Staff Representative
From: Allayne Donnelly-Everett, Administrative Recorder
Re: Regulatory Zone Amendment Case Number RZA14-004 (Autumn Trails)
Date: June 27, 2014

Regulatory Zone Amendment Case Number RZA14-004 (Autumn Trails) – Applicant/Property Owner: Pinnacle Land Holdings, LLC. Mike Vicks, Monte Vista Consulting provided information for review and recommendations on the request to consider an amendment to the Regulatory Zone map and zoning designation within the Spanish Springs planning area; and, if approved, forward to the Board of County Commissioners for approval. The amendment request will re-designate ±23.61 acres of a ±47.6 acre parcel from Low Density Suburban (LDS) to Low Density Suburban 2 (LDS2) zoning. The proposed Regulatory Zone Amendment would increase the total density of the subject ±47.6 acre parcel by 16 residential dwelling units. To reflect requested changes and to maintain currency of general planning area data, administrative changes are proposed and include a revised map with updated parcel base, and other matters properly relating thereto without prejudice to the final dispensation of the proposed amendments. Assessor's Parcel Number: 534-420-08 Section/Township/Range: Within Section 25, T21N, R20E, MDM. Washoe County, NV Staff: Trevor Lloyd, Senior Planner, Washoe County Community Services Department, Planning and Development Division, Phone: 775-328-3620, E-mail: tlloyd@washoecounty.us Meeting Date: Planning Commission Tuesday, July 1, 2014. **MOTION:** Dawn Costa-Guyon moved to recommend approval of RZA14-004 Autumn Trails as presented. Catherine Gustavson seconded the motion. The motion carried with five in favor and Ken Theiss abstaining.

Comments and Concerns

- In response to questions raised, Mr. Vicks stated that previously there was 185 acres with one lot per acre. The new proposed density is for the addition of twelve to sixteen new lots with 1.08 houses per acre. The proposed amendment is in conformance with the underlying zoning. Some lots will be less than one acre and some others will be one acre plus. This development is a common open space community. Development will be limited to the previously planned single family homesites. The applicant still has to go through the tentative map process.
- Roger Pelham, Senior Planner stepping in for Trevor Lloyd, Senior Planner reminded the CAB and members of the audience that this hearing is a request for a regulatory zone amendment and increased density.
- Concerns were raised regarding whether a traffic study has been or will be conducted. Mr. Vicks stated that a traffic study would not be required for this proposed amendment.
- In response to questions raised, Mr. Pelham stated that Clara Lawson, Washoe County Engineering would address questions regarding traffic issues.
- In response to questions raised, Mr. Pelham stated that this type of request has not been presented in the Spanish Springs planning area, however a very similar situation was submitted in the Golden Valley area.

cc: Vaughn Hartung, Commissioner
David Espinosa, Chair
Al Rogers, Director, Constituent Services
Andrea Tavener, Constituent Services

From: Anderson, Christopher

Sent: Thursday, October 09, 2014 2:01 PM

To: Lloyd, Trevor

Cc: English, James; Sack, Bob; mfiore@phdncv.com; jared@k2eng.net; Michael

Vicks

Subject:TM14-002 Autumn Trails Subdivision - Tentative Map Review

Follow Up Flag: Follow up

Flag Status: Flagged

Washoe County Health District, Environmental Health Services Division (Division) has reviewed the above referenced project with regard to sewage disposal, domestic water supply, solid waste and water quality. The project is proposing a 47.608 acre, 43-lot, single-family residential subdivision with an average lot size of 31,972 square feet on APN 534-420-08. The development is proposed to be served by public water and sewer.

This Division requires the following conditions to be completed prior to review and approval of any Final Map:

1) Grading and drainage shall not impact the adjacent on-site sewage disposal systems in the adjacent Bridal Path subdivision in any manner that would result in non-compliance of said on-site sewage disposal systems with the Washoe County District Board of Health Sewage, Wastewater and Sanitation regulations.

2) Prior to any grading or other site improvements, a complete water system plan and Water Project

submittal for the referenced proposal must be submitted to this Division. The plan must show that

the water system will conform to the State of Nevada Public Water Supply Regulations, NAC Chapter 445A, and the State of Nevada Regulations Governing Review of Plans for Subdivisions, Condominiums, and Planned Unit Developments, NAC 278.400 and 278.410.

a) Two copies of all plans are required for review. All plans must include an overall site plan, additional phases that will eventually be built to indicate that the water system will be looped, all proposed grading, utilities, and improvements for the proposed application.

b) Any construction activities (including but not limited to mass grading of the site) conducted prior to the review and approval of the required Water Project and submittal and approval of a Final Map are in violation of NAC 445A.6666, NAC 445A.6669, and NAC 278.340.

3) Pursuant to NAC 278.340 of the State of Nevada Regulations Governing Review of plans for Subdivision, Condominiums, and Planned Unit Developments, no construction (including grading) shall be performed prior to the Washoe County Health District approval of the referenced Final Map.

4) Grading shall be performed in compliance with current best management practices and mosquito-breeding sources must be eliminated within graded areas.

a) Grading plans must be reviewed and approved by the Washoe County Health District Vector Borne-Disease Program.

5) Construction plans for the development must be submitted to this Division for approval. The construction drawings must conform to the State of Nevada Regulations Concerning Review of Plans for Subdivisions, Condominiums and Planned Unit Developments, and any applicable requirements of the Washoe County Health District.

6) Prior to approval of a Final Map for the referenced project and pursuant to NAC 278.370, the design engineer is required to submit to the satisfaction this Division an inspection plan for periodic inspection of the construction of the systems for water supply and community sewerage. The design engineer shall, pursuant to the approved inspection plan, periodically certify in writing to

the Division that the improvements are being installed in accordance with the approved plans and recognized practices of the trade.

- a) A copy of the inspection plan must be included with the Final Map submittal.
- 7) Prior to final approval, a “Commitment for Service” letter from the sewage purveyor committing sewer service for the entire proposed development must be submitted to the Division. The letter must indicate that the community facility for treatment will not be caused to exceed its capacity and the discharge permit requirements by this added service, or the facility will be expanded to provide for the added service.
 - a) A copy of this letter must be included with the Final Map submittal.
- 8) Prior to final approval, a “Commitment for Water Service” letter from the water purveyor committing adequate water service for the entire proposed development must be submitted to the Division.
 - a) A copy of this letter must be included with the Final Map submittal.
- 9) The Final Map application packet must include a letter from Nevada Division of Environmental Protection to the Health District certifying their approval of the Final Map.
 - a) A copy of this letter must be included with the final map submittal.
- 10) Pursuant to NAC 278.360 of the State of Nevada Regulations Governing Review of plans for Subdivision, Condominiums, and Planned Unit Developments, the development of the subdivision must be carried on in a manner which will minimize water pollution.
- 11) Prior to approval of the final map, the applicant must submit to this Division the Final Map fee.

Please contact me if you have any questions.

Regards,

Chris Anderson, PE

Environmental Health Services

Washoe County Health District

Chris Anderson, PE

1001 East Ninth Street

PO Box 11130, Reno, NV 89520-0027

Dir: (775) 328-2632

Cell: (775) 830-9263

FAX: (775) 328-6176

CAnderson@washoecounty.us



Washoe County Health District

ENVIRONMENTAL HEALTH SERVICES DIVISION



Public Health
Prevent. Promote. Protect.

Planning and Development Division
Community Services Department
Attn: Trevor Lloyd

November 4, 2014

Dear Trevor,

After review of the **Tentative Subdivision Map Case Number TM14-002 (Autumn Trails)**, Washoe County Health District Vector-Borne Diseases Program will require the following items as a condition for final approval:

1. At a minimum the new storm water detention basin will require a rock lined low flow channel connecting the inlet and outlet pipe. A concrete low flow channel is preferred.
2. The existing storm water detention basin currently has a rock lined low flow channel. If any changes are made to this basin the low flow channel should be protected, repaired, or replaced.
3. A minimum 18 inch xeriscape catchment area will be required for the typical front lots between any turf grass and impervious surfaces. A 24 inch or greater catchment is preferred.

If there are any or concerns, please contact me at 785-4599.

Sincerely,

A handwritten signature in cursive script, appearing to read "Jeff Jeppson".

Jeff Jeppson
Vector-Borne Disease Specialist
Environmental Health Services
Washoe County Health District

CC: Jim Shaffer, WCHD
Denise Cona, WCHD



WASHOE COUNTY

COMMUNITY SERVICES DEPARTMENT

Engineering and Capital Projects Division

"Dedicated to Excellence in Public Service"

1001 East 9th Street PO Box 11130 Reno, Nevada 89520 Telephone: (775) 328-2040 Fax: (775) 328-3699

INTEROFFICE MEMORANDUM

DATE: October 09, 2014
TO: Trevor Lloyd, Planning and Development Division
FROM: Leo R. Vesely, P.E., Engineering and Capitol Projects Division
SUBJECT: **TM14-002**
APN 534-420-08
TENTATIVE MAP – AUTUMN TRAILS

I have reviewed the referenced tentative map application and have the following conditions:

1. Final maps and final construction drawings shall comply with all applicable statutes, ordinances, rules, regulations, and policies in effect at the time of submittal of the tentative map or, if requested by the developer and approved by the applicable agency, those in effect at the time of approval of the final map.
2. Prior to acceptance of public improvements and release of any financial assurances, the developer shall furnish to the water and sewer provider(s) and Engineering Division a complete set of reproducible as-built construction drawings prepared by a civil engineer registered in the State of Nevada.
3. The developer shall be required to participate in any applicable General Improvement District or Special Assessment District formed by Washoe County. The applicable County Department shall be responsible for determining compliance with this condition.
4. The developer shall provide written approval from the U.S. Postal Service concerning the installation and type of mail delivery facilities. The system, other than individual mailboxes, must be shown on the project construction plans and installed as part of the onsite improvements. The County Engineer shall determine compliance with this condition.
5. All open space shall be identified as common area on the final map. A note on the final map shall indicate that all common areas shall be privately maintained and perpetually funded by the Homeowners Association. The County Engineer shall determine compliance with this condition. The maintenance of the common areas shall also be addressed in the CC&Rs to the satisfaction of the District Attorney's Office.
6. Any existing easements or utilities that conflict with the development shall be relocated, quitclaimed, and/or abandoned, as appropriate. The County Engineer shall determine compliance with this condition.

TM14-002
EXHIBIT F

7. Any easement documents recorded for the project shall include an exhibit map that shows the location and limits of the easement in relationship to the project. The County Engineer shall determine compliance with this condition.
8. All existing overhead utility lines shall be placed underground, except electric transmission lines greater than 100 kilovolts, which can remain above ground. The County Engineer shall determine compliance with this condition.
9. A complete set of construction improvement drawings, including an onsite grading plan, shall be submitted to the County Engineer for approval prior to finalization of any portion of the tentative map. Grading shall comply with best management practices (BMP's) and shall include detailed plans for grading and drainage for lots, project roadways, erosion control (including BMP locations and installation details), slope stabilization and mosquito abatement. A conceptual grading and drainage scheme shall be indicated for each lot on the grading plan. If drainage from one lot to another is proposed, then appropriate drainage easements shall be provided. Disposal of any excavated material onsite shall be indicated on the grading plans. The County Engineer shall determine compliance with this condition.
10. A grading bond of \$2,000/acre of disturbed area shall be provided to the Engineering Division prior to issuance of a grading permit.
11. The conditional approval of this tentative map shall not be construed as final approval of the drainage facilities shown on the tentative map. Final approval of the drainage facilities will occur during the final map review and will be based upon the final hydrology report.
12. Prior to finalization of any portion of the tentative map, a final, detailed hydrology/hydraulic report for that unit shall be submitted to the County Engineer. The hydrology/hydraulic report shall be consistent with the master drainage plan for Sky Ranch North Unit 2. All storm drainage improvements necessary to serve the project shall be designed and constructed to County standards and specifications and/or financial assurances in an appropriate form and amount shall be provided. The County Engineer shall determine compliance with this condition.
13. Any increase in stormwater runoff resulting from development and base on the 100-year storm shall be detained. The County Engineer shall determine compliance with this condition.
14. Standard reinforced concrete headwalls or other approved alternatives shall be placed on the inlet and outlet of all drainage structures, and grouted rock riprap shall be used to prevent erosion at the inlets and outlets of all culverts to the satisfaction of the Engineering Division.
15. The applicant shall provide pretreatment for petrochemicals and silt for all storm drainage from the site to the satisfaction of the County Engineer.
16. The developer shall obtain a Stormwater Discharge Permit from the Nevada Division of Environmental Protection (NDEP), and a copy of the permit shall be submitted to the County Engineer. The Stormwater Pollution Prevention Plan shall be included with the subdivision improvement drawings.
17. The Truckee Meadows Regional Stormwater Quality Management Program Construction Permit Submittal Checklist and Inspection Fee shall be submitted with each final map. The County Engineer shall determine compliance with this condition.

18. Drainage swales that drain more than two lots are not allowed to flow over the curb into the street; these flows shall be intercepted by an acceptable storm drain inlet and routed into the storm drain system. The County Engineer shall determine compliance with this condition.
19. A note on the final map shall indicate that all drainage facilities not maintained by Washoe County shall be privately maintained and perpetually funded by a homeowners association. The maintenance and funding of these drainage facilities shall also be addressed in the CC&Rs to the satisfaction of the District Attorney's Office. The County Engineer shall determine compliance with this condition.
20. The maximum permissible flow velocity (that which does not cause scour) shall be determined for all proposed channels and open ditches. The determination shall be based on a geotechnical analysis of the channel soil, proposed channel lining and channel cross section, and it shall be in accordance with acceptable engineering publications/calculations. Appropriate linings shall be provided for all proposed channels and open ditches such that the 100-year flows do not exceed the maximum permissible flow velocity. The County Engineer shall determine compliance with this condition.
21. All slopes steeper than 5:1 shall be stabilized to control erosion. The County Engineer shall determine compliance with this condition.
22. Maintenance access and drainage easements shall be provided for all existing and proposed drainage facilities. The County Engineer shall determine compliance with this condition.
23. Drainage easements shall be provided across individual lots on the official map for all storm runoff that crosses more than one lot. The County Engineer shall determine compliance with this condition.
24. Common Area drainage onto residential lots shall be intercepted and routed to appropriate storm drainage facilities. The County Engineer shall determine compliance with this condition.
25. All roadway improvements necessary to serve the project shall be designed and constructed to County standards and specifications and/or financial assurances in an appropriate form and amount shall be provided. The County Engineer shall determine compliance with this condition.
26. Street names shall be reviewed and approved by the Regional Street Naming Coordinator.
27. Proposed landscaping and/or fencing along street rights-of-way and within median islands shall be designed to meet American Association of State Highway and Transportation Officials (AASHTO) sight distances and safety guidelines. No tree shall overhang the curb line of any public street. The County Engineer shall determine compliance with this condition.
28. Sidewalks shall be constructed in accordance with current Washoe County standards for street improvements.
29. For any utilities placed in existing County streets, the streets shall be repaired to the satisfaction of the County Engineer. At a minimum, this will require full depth removal

and replacement of asphalt for half the street width, or replacement of non-woven pavement reinforcing fabric with a 2" asphalt overlay for half the street width. Type II slurry seal is required for the entire street width with either option. Full width street improvements may be required if the proposed utility location is too close to the centerline of the existing street.

30. Streetlights shall be constructed to Washoe County standards at locations to be determined at the final design stage. The County Engineer shall determine compliance with this condition.
31. AASHTO clear zones shall be determined for all streets adjacent to retaining walls or slopes steeper than 3:1. If a recoverable or traversable clear zone cannot be provided, an analysis to determine if barriers are warranted shall be submitted for approval. The County Engineer shall determine compliance with this condition.
32. Any retaining walls that are adjacent to, provide support for or retain soil from the County right-of-way shall be constructed of reinforced masonry block or reinforced concrete and designed by an engineer licensed in the State of Nevada. The County Engineer shall determine compliance with this condition.
33. An adequate easement for snow storage and signage shall be identified on the final plat. The County Engineer shall determine compliance with this condition.

LRV/lrv

Amy Ray
Fire Marshal



Tim Leighton
Division Chief

Charles A. Moore
Fire Chief

October 10, 2014

Washoe County Community Services Department
1001 East Ninth Street
Reno, NV 89512

Re: Tentative Subdivision Map Case Number 14-002 (Autumn Trails)

The Truckee Meadows Fire Protection District (TMFPD) will approve permit with the following conditions:

- The CC&Rs/HOA regulations shall require that provisions be made to monitor, maintain and update, every three (3) years regardless of ownership, a maintenance plan for the common open space area. This plan shall be reviewed and approved by TMFPD.
- The maintenance of defensible space, dependent upon the fire hazard assessment rating, as designated by the *International Wildland Urban Interface Code* and the fire hazard map per NAC 472, shall be required.
- Additional language shall be provided to include approval of the required landscaping plan by TMFPD in compliance with the *International Wildland Urban Interface Code*.
- TMFPD recommends that the developer put up a bond for continued maintenance of open space and common areas shall the Homeowners Association cease to exist or fail to maintain these areas, as required, due to lack of funding or participation.
- This development and all land and structures, shall meet the provisions of the WCC 60.

Please call me with questions at 775-326-6005.

Regards,

Amy Ray
Fire Marshal

TRUCKEE MEADOWS FIRE PROTECTION DISTRICT

1001 E. Ninth St. Bldg D 2nd Floor • Reno, Nevada 89512 • PO Box 11130 • Reno, Nevada 89520
Office 775.326.6000 Fax 775.326.6003

**TM14-002
EXHIBIT G**

From: Boster, Mike [MBoster@washoeschools.net]
Sent: Friday, October 17, 2014 8:40 AM
To: Lloyd, Trevor
Subject: WCSD Disclosure Statement

Trevor,

WCSD has begun to request the following disclosure on most tentative maps and other projects that result in additional housing units:

A disclosure shall be made by the developer to each homebuyer on their closing documents that students in this subdivision may be assigned to the nearest school(s) with available capacity in the event that the zoned schools cannot accommodate additional students.

Please add this to the conditions for the Autumn Hills TM. Thank you for your help.

Mike

Michael S. Boster
School Planner
[Washoe County School District Capital Projects](#)
14101 Old Virginia Road
Reno NV 89521
775.789.3810



OFFICIAL NOTICE OF PUBLIC HEARING

DATE: October 29, 2014

You are hereby notified that the **Washoe County Planning Commission** will conduct a public hearing at the following time and location:

6:30 p.m., Thursday, November 13, 2014
County Commission Chambers, 1001 East Ninth Street, Reno, NV 89512

Regulatory Zone Amendment Case Number RZA14-004 (Autumn Trail) – To consider recommendation of a proposed amendment to the regulatory zone map and regulatory zone within the Spanish Springs planning area; and, if approved, forward to the Board of County Commissioners for adoption. The proposed amendment will re-designate ±6 acres of a ±47.6 acre parcel from a regulatory zone of Low Density Suburban (LDS) to Medium Density Suburban (MDS). The proposed regulatory zone amendment would increase the total density of the subject ±47.6 acre parcel by 12 residential dwelling units. To reflect requested changes and to maintain currency of general planning area data, administrative changes are proposed and include a revised map with updated parcel base, and other matters properly relating thereto without prejudice to the final dispensation of the proposed amendments.

and

Tentative Subdivision Map Case Number TM14-002 (Autumn Trails) – Possible approval of a Tentative Subdivision Map to develop a 43-lot, single-family residential, common open space subdivision. Lots will range in size from 21,451 to 58,393 square-feet, and the common open space area will be approximately 12.3 acres.

- Applicant/Property Owner: Pinnacle Land Holdings, LLC
- Address/Location: 0 Hayfield Drive
- Assessor's Parcel Number: 534-420-08
- Parcel Size: ±47.608 acres
- Master Plan Category: Suburban Residential (SR)
- Regulatory Zone: Low Density Suburban (LDS)
- Area Plan: Spanish Springs Area Plan
- Citizen Advisory Board: Spanish Springs
- Development Code: Authorized in Article 821, Amendment of Regulatory Zone and Article 608, Subdivision Regulations
- Commission District: 4 – Commissioner Hartung
- Section/Township/Range: Within Section 25, T21N, R20E, MDM
Washoe County, NV
- Staff: Trevor Lloyd, Senior Planner
Washoe County Community Services Department
Planning and Development Division
- Phone: 775-328-3620
- E-mail: tlloyd@washoecounty.us

As an owner of property in the vicinity, you are invited to present testimony relative to these matters. To access additional information about this item, please visit our website at www.washoecounty.us/comdev/, choose **Boards and Commissions**, then **Planning Commission**. A staff report related to this public hearing will be posted on Friday, four days prior to the meeting.



Community Services Department
Planning and Development Division for the
Washoe County Planning Commission
1001 E. Ninth St., Bldg. A, Reno, NV 89512
Post Office Box 11130, Reno, NV 89520-0027

Address Service Requested

OFFICIAL NOTICE OF PUBLIC HEARING

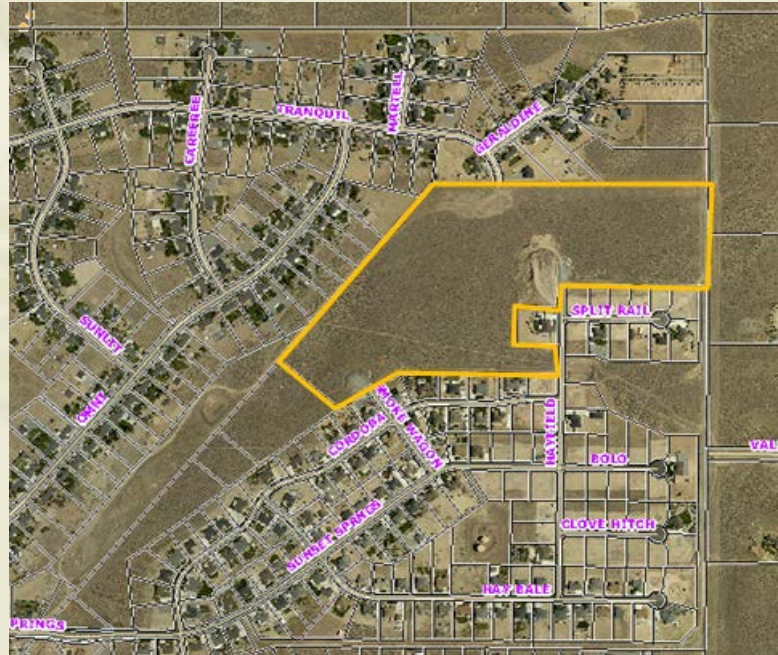

**Washoe County
Planning Commission –
November 13, 2014**

Autumn Trails
Regulatory Zone Amendment: RZA14-004
and
Tentative Map: TM14-002

Vicinity Map

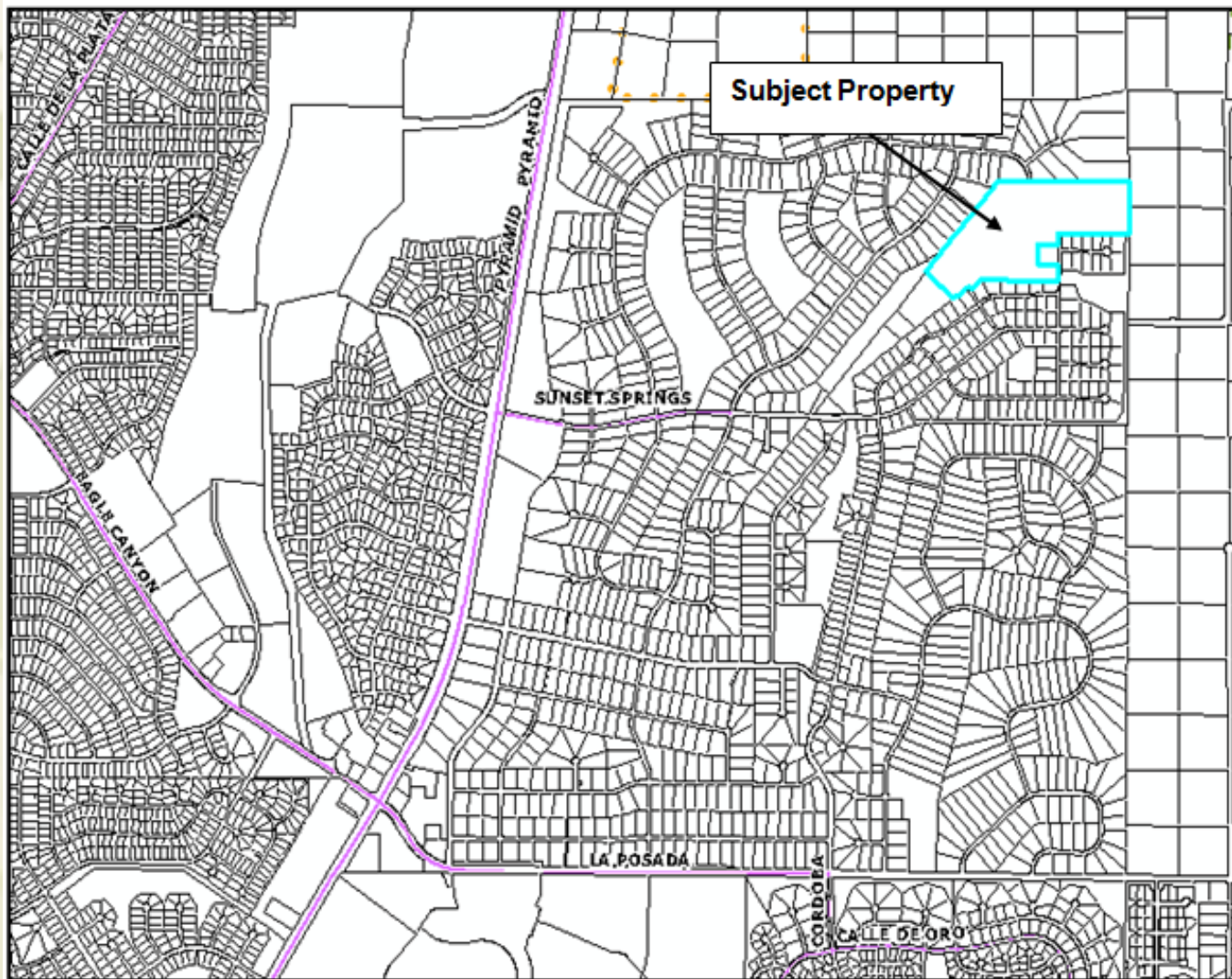

Proposed Regulatory Zone Amendment

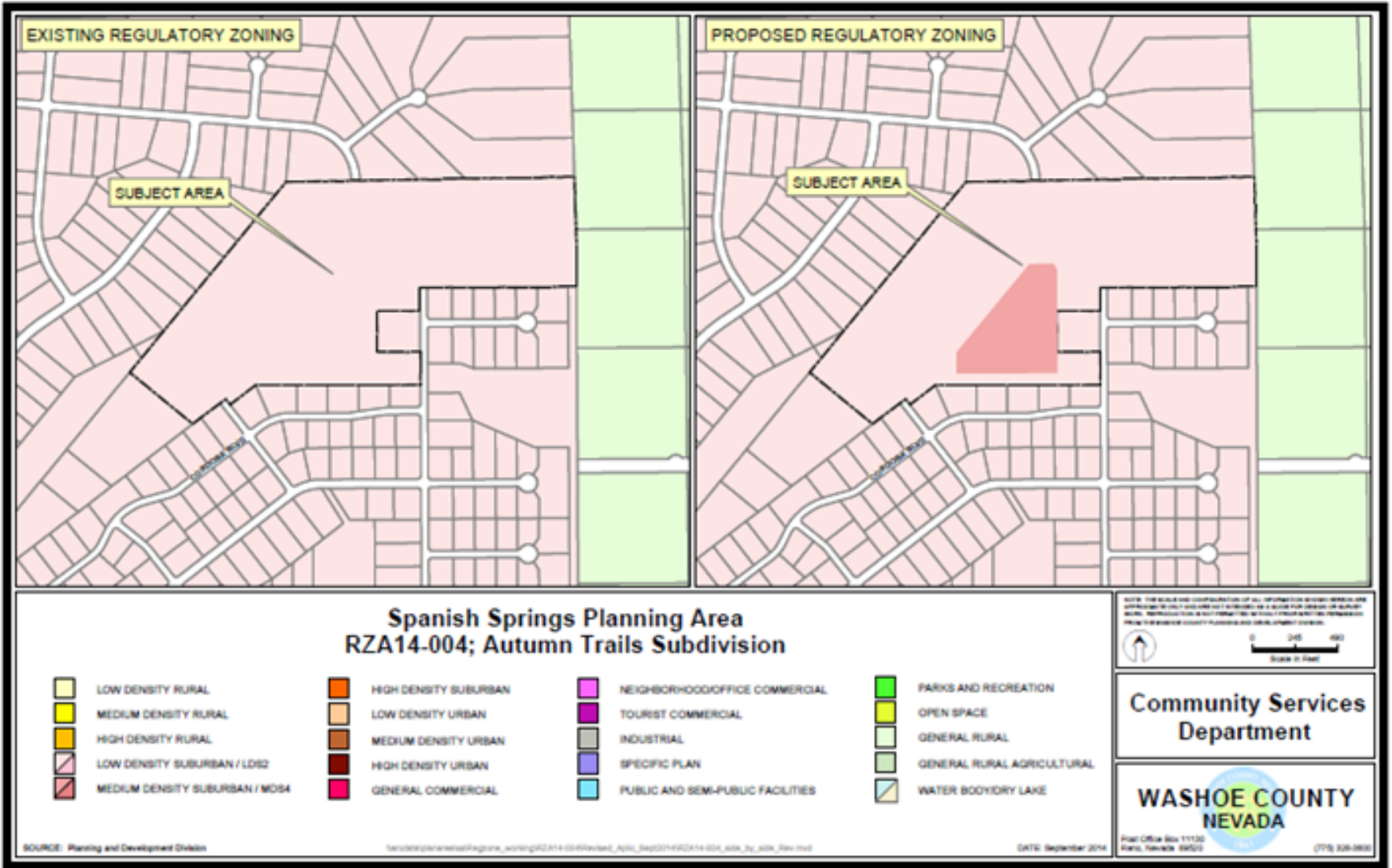

Regulatory Zone Amendment (Important Facts)

- 47 acres currently zoned Low Density Suburban (LDS) (1 unit per acre)
- 6 acres of Medium Density Suburban (MDS) (3 units per acre)
- RZA will result in a density of 43 lots.
- Proposed RZA is consistent with all goals and policies of the Master Plan and Spanish Springs Area Plan.

Proposed Tentative Map

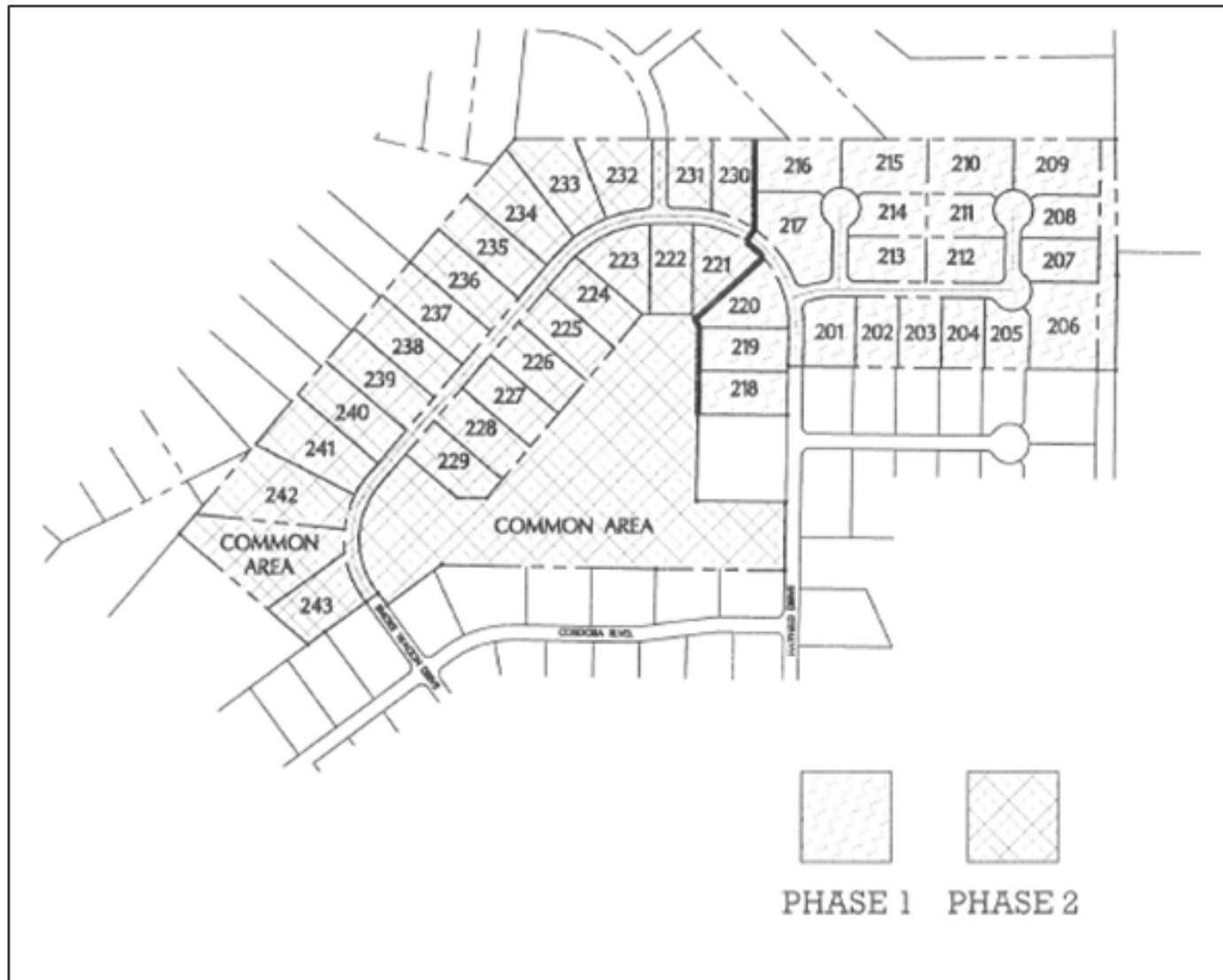

Tentative Map Grading Plan

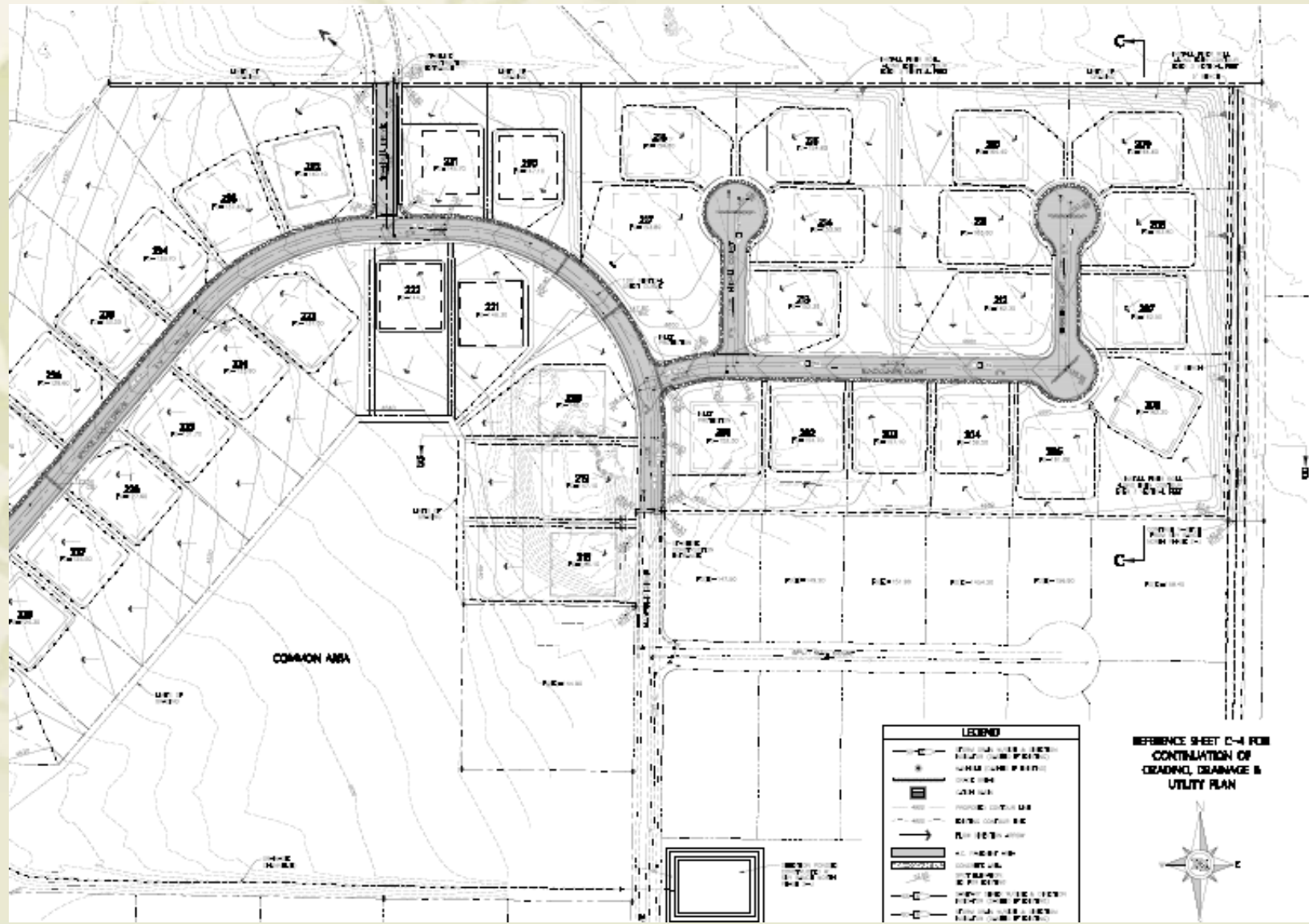

Tentative Map (Important Facts)

- 43 Lots proposed
- Lots will range from 21,451 s.f. to 58,393 s.f.
- 12.3 acres of Common Open Space proposed
- Lot sizes are compatible with surrounding lot sizes.
- Proposed Tentative Map is consistent with all goals and policies of the Master Plan and Spanish Springs Area Plan.

Existing Dirt Stockpile



Spanish Springs Citizen Advisory Board

RZA14-004 and TM14-002 approved on
September 10, 2014 by the SSCAB.

Motion for RZA14-004

After giving reasoned consideration to the information contained in the staff report and information received during the public hearing, I move to approve Regulatory Zone Amendment Case Number RZ14-004, having made all of the following findings in accordance with Washoe County Development Code Section 110.821.15, and to adopt the resolution contained in Exhibit A recommending that the Washoe County Board of County Commissioners adopt the Regulatory Zone Amendment. I further move to authorize the Chair to sign the resolution contained in Exhibit A on behalf of the Washoe County Planning Commission.

Motion for TM14-002

I move that after giving reasoned consideration to the information contained in the staff report and information received during the public hearing, the Washoe County Planning Commission approve Tentative Subdivision Map Case Number TM14-002 for Pinnacle Land Holdings, LLC, with the Conditions attached as Exhibit A of the staff report, having made all ten findings in accordance with Washoe County Development Code Section 110.608.25.